

4200SB

SPLIT BASE

4200SB

BASE

TWO PIECE WRAPAROUND, CORROSION RESISTANT, DURABLE CAST ALUMINUM CONSTRUCTION. MINIMUM .250 WALL THICKNESS. BASE CONSISTS OF A SMOOTH STEPPED BOTTOM SECTION WITH FLUSH HAND HOLE AND A DECORATIVE TAPERED FLUTED SECTION CONSISTING OF EVENLY SPACED, HIGHLY DETAILED RAISED VERTICAL FLUTES. HAND HOLE COVER SUPPLIED WITH TAMPER RESISTANT HARDWARE. (4) 1/4"-20 SET SCREWS PROVIDED TO SECURE DECORATIVE BASE TO SHAFT.

FINISH

ELECTROSTATICALLY APPLIED BAKED ON TEXTURED ACRYLIC ENAMEL. (SEE PAGE 5 FOR OPTIONAL FINISH AND COLOR SELECTION)

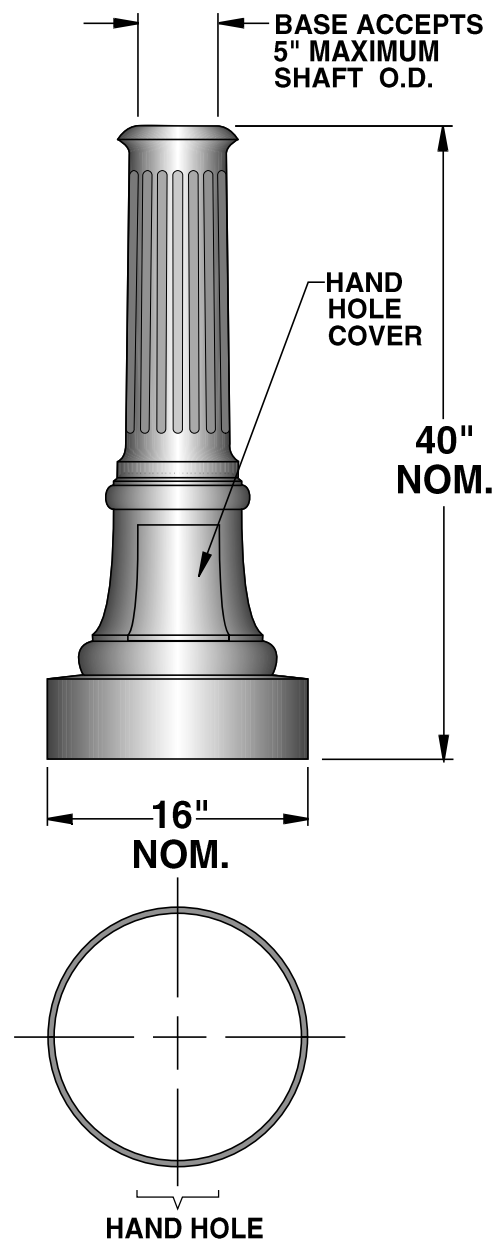

The Lighting Tradition

sun valley
LIGHTING

660 WEST AVENUE O, PALMDALE, CA 93551
(661) 233-2000
FAX (661) 233-2001
www.sunvalleylighting.com

SB-23

ACCESSORIES

(SPECIFY AS SUFFIX TO CAT. NO.)

TENONS

- 2 3/8" O.D.  PT23
- 2 7/8" O.D.  PT27
- 3 1/2" O.D.  PT31

- DUPLEX OR G.F.I. RECEPTACLE WITH COVER  DUP
GFI

- FIELD ROTATABLE OR FIXED BANNER ARM  RBA
FBA

- BANNER EYE BOLT  BEB

- BREAK AWAY BANNER ARM  BBA

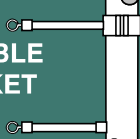
- FIELD ROTATABLE OR FIXED BASKET HOLDER  RBH
FBH

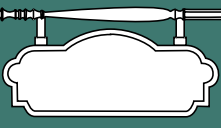
- FIELD ROTATABLE STREET SIGN  RSS

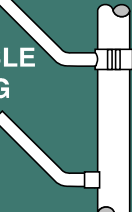
- FIELD ROTATABLE OR FIXED FLAG HOLDER  RFH
FFH

1 3/8" I.D.

SCALE: 1/2"=1'-0"

ROUND TAPERED STEEL

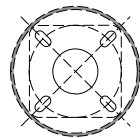
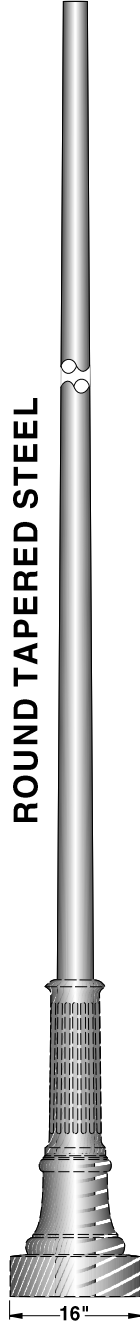

OCTAFLUTE STEEL

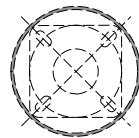
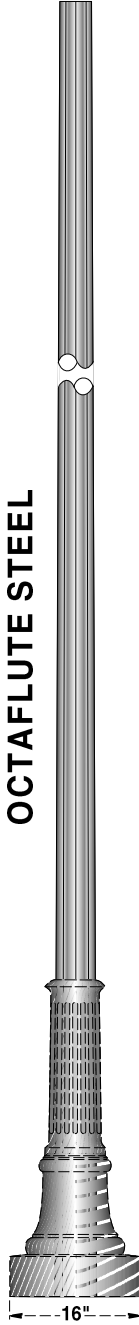

ROUND STRAIGHT STEEL

