

H.I.D AREA LIGHTING

B3500 SERIES-HID

S P E C I F I C A T I O N S

HOUSING and RISER

Durable, corrosion resistant cast aluminum (A356 alloy; < 0.2% Cu) base, unlit riser and top cap, minimum .250" wall thickness. Lit riser is extruded, minimum .188" wall thickness. All visible welds are blended, all exposed hardware is stainless steel.

OPAL LENS (WA)

Opal acrylic lens is located at the recess of the vertical flutes, protects the internal lamp and provides uniform, diffuse illumination.

ELECTRICAL MODULE

All electrical components are UL and cUL recognized are mounted on a single plate and factory prewired with quick-disconnect plugs. All HID lamps are medium base (E26) or Bi-pin Base (G12). Electronic MH ballasts have a power factor of >.95 (35/39W - 100W) -20°F starting, 120-277V and have lamp End-of-life protection. 347V option utilizes a step down transformer to the electronic ballast. Magnetic MH ballasts are high power factor (35/39W - 100W), -20°F starting, multi-tap 120-277V, 60Hz. All HPS ballasts are core and coil, high-reactance, high power factor (35/39W - 100W), -40°F starting. Electronic CFL ballasts are high power factor 120 - 277 voltage sensing. GX24-q4 socket supplied for all 18w - 42w triple tube lamps.

FINISH

Electrostatically applied TGIC Polyester Powder Coat on substrate prepared with 20 PSI power wash at 140°F. Four step media blast and iron phosphate pretreatment for protection and paint adhesion. 400°F bake for maximum hardness and durability.

PROJECT NAME: _____

PROJECT TYPE: _____



B35EL-CAP

PATENT PENDING



2014246

B3500 SERIES-HID

SPECIFICATIONS

GROUND MOUNTING

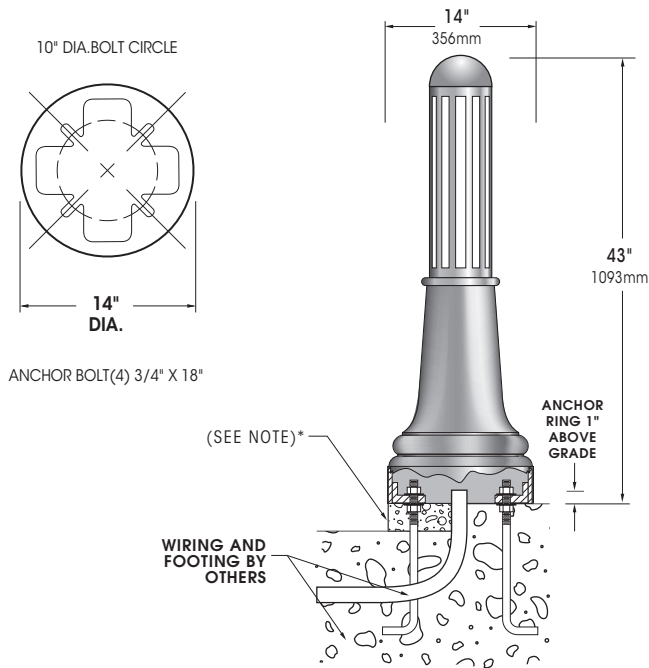

*When mounting in soil, anchor bolt fasteners and other hardware must be protected from soil by grouting.

LAMP WATTAGE

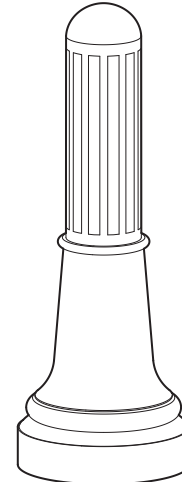

B35EL-CAP
LAMP SIZE: 35 - 100WATT

Spec/Order Example: B35EL-CAP/VL-SYM/50THPS347/RAL-9005-S/GFI

LIGHTED SPEC/ORDERING INFORMATION

MODEL	OPTICS	WATTAGE	TYPE	VOLTAGE	FINISH	OPTIONS	
MODEL	OPTICS	LAMP			FINISH	OPTIONS	
LIGHTED		WATTAGE	TYPE	VOLTAGE	STANDARD TEXTURED FINISH		
<input type="checkbox"/> B35EL-CAP	<input type="checkbox"/> VERTICAL LAMPVL-SYM	<input type="checkbox"/> 100 <input type="checkbox"/> 70T ¹ <input type="checkbox"/> 70 <input type="checkbox"/> 50T ¹ <input type="checkbox"/> 50 <input type="checkbox"/> 42CFL ² <input type="checkbox"/> 35HPS	<input type="checkbox"/> PSMH <input type="checkbox"/> HPS	<input type="checkbox"/> 120 <input type="checkbox"/> 208 ³ <input type="checkbox"/> 240 <input type="checkbox"/> 277 <input type="checkbox"/> 347 ⁴ <input type="checkbox"/> 480	<input type="checkbox"/> BLACK RAL-9005-T <input type="checkbox"/> WHITE RAL-9003-T <input type="checkbox"/> GREY RAL-7004-T <input type="checkbox"/> DARK BRONZE RAL-8019-T <input type="checkbox"/> GREEN RAL-6005-T	INTERNAL HOUSE SIDE SHIELD <input type="checkbox"/> 90° HS90 <input type="checkbox"/> 135° HS135 <input type="checkbox"/> 180° HS180 <input type="checkbox"/> DIMMABLE DRIVER(S) (0-10V) DIM <input type="checkbox"/> HIGH-LOW DIMMING FOR HARDWIRED SWITCHING OR NON-INTEGRATED MOTION SENSOR HLSW <input type="checkbox"/> 10KV SURGE PROTECTOR. 10SP <input type="checkbox"/> 20KV SURGE PROTECTOR (240V & 480V Only) ... 20SP <input type="checkbox"/> DUPLEX RECEPTACLE ... DUP <input type="checkbox"/> GROUND FAULT RECEPTACLE GFI <input type="checkbox"/> MAILBOX - SINGLE MBS <input type="checkbox"/> MAILBOX - DOUBLE MBD <input type="checkbox"/> BOLLARD EYE BOLT BEB	
		NOTES: 1 - TUBULAR LAMP, G12 BASE 2 - GX24q-4 BASE SUITABLE FOR 3 - N/A FOR 35HPS ANFD 50HPS TUBE LAMPS 42 WATT TRIPLE 18 THRU 4 - N/A FOR 35HPS				FOR SMOOTH FINISH REPLACE SUFFIX "T" WITH SUFFIX "S" (EXAMPLE: RAL-9500-S) SEE USALTG.COM FOR ADDITIONAL COLORS	

B3500 SERIES-HID

S P E C I F I C A T I O N S

HOUSING and RISER

Durable, corrosion resistant cast aluminum (A356 alloy; < 0.2% Cu) base, riser and top cap, minimum .250" wall thickness. All visible welds are blended, all exposed hardware is stainless steel.

FINISH

Electrostatically applied TGIC Polyester Powder Coat on substrate prepared with 20 PSI power wash at 140°F. Four step media blast and iron phosphate pretreatment for protection and paint adhesion. 400°F bake for maximum hardness and durability.

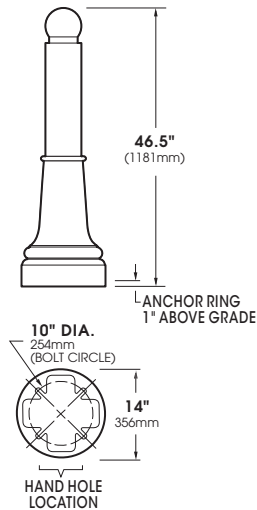

B 3 5 E - B A L



PATENT PENDING

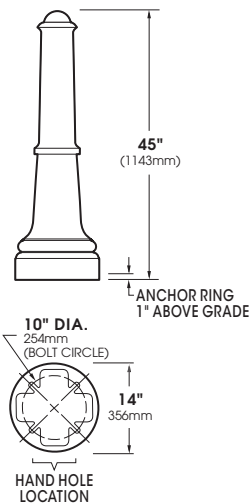

B 3 5 C - C A P



PATENT PENDING

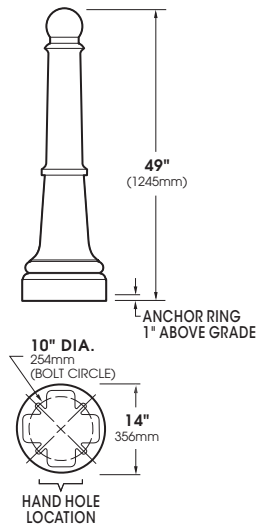

B 3 5 C - B A L



PATENT PENDING

ACCESSORIES

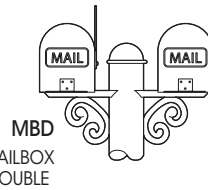
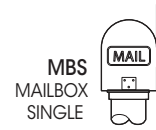

Mailboxes may be mounted post top or side mount.

Mailboxes are of durable, corrosion resistant, cast aluminum (A356 alloy; < .02% copper) and painted to match the decorative bollard.

Mailboxes include nonlocking pull latch and cast flag.

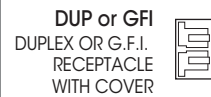

Specify Duplex or GFCI receptacle to mount in the outlet provision. Standard cover supplied.

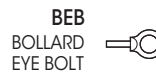

Eyebolts for barrier chain or cord. Specify eyebolt(s) height and location.

Unlit Example: B35C-CAP/RAL-8019-T

UN-LIGHTED SPEC/ORDERING INFORMATION

MODEL	FINISH	ACCESSORIES
MODEL	FINISH	ACCESSORIES
UN-LIGHTED	STANDARD TEXTURED FINISH	
<input type="checkbox"/> B35E-BAL	<input type="checkbox"/> BLACK RAL-9005-T	<input type="checkbox"/> MAILBOX - SINGLE MBS
<input type="checkbox"/> B35C-CAP	<input type="checkbox"/> WHITE RAL-9003-T	<input type="checkbox"/> MAILBOX-DOUBLE MBD
<input type="checkbox"/> B35C-BAL	<input type="checkbox"/> GREY RAL-7004-T	<input type="checkbox"/> DUPLEX RECEPTACLE DUP
TO CONFIGURE, SHOW MODEL, FINISH AND ANY PERTINENT ACCESSORIES	<input type="checkbox"/> DARK BRONZE RAL-8019-T	<input type="checkbox"/> GROUND FAULT RECEPTACLE GFI
	<input type="checkbox"/> GREEN RAL-6005-T	BOLLARD EYE BOLT
	FOR SMOOTH FINISH REPLACE SUFFIX "T" WITH SUFFIX "S" (EXAMPLE: RAL-9500-S)	<input type="checkbox"/> SINGLE BEB
	SEE USALTG.COM FOR ADDITIONAL COLORS	<input type="checkbox"/> DOUBLE BEB/2-180