

SOLID STATE AREA LIGHTING

DSCP SERIES-LED

SPECIFICATIONS

HOUSING Upper housing is heavy gauge cast aluminum (DSCP25) or 0.125" thick spun aluminum with reveal (DSCP1). Lower housing is 0.080" thick spun aluminum with integrated LED module seat. Lower housing is vented at top and bottom for convective cooling of LED module. Top Driver chamber is sealed from LED Module chamber. Trulevel ball coupling mount is welded to housing and facilitates quick leveling and installation.

✓LED[®] OPTICAL MODULE

Low copper A356 alloy (<.2% copper) cast aluminum housing. Integrated clear tempered 3/16" glass lens sealed with a continuous silicone gasket protects emitters (LED's) and emitter Reflector-Prism optics, and seals the module from water intrusion and environmental contaminants. LED's are available in standard Neutral White (4000K), or optional Cool White (5000K) or Warm White (3000K). Each emitter is optically controlled by a Reflector-Prism injection molded from H12 acrylic (3 types per module; one from 0° - 50°; one from 50° - 65°; one from 65° - 72°). Each Reflector-Prism has indexing pins for aiming and is secured to an optical plate made of matte black anodized aluminum. The optical plate locates every Reflector-Prism over an emitter. Reflector-Prisms are secured to the optical plate with a UV curing adhesive. The Reflector-Prisms are arrayed to produce IES Type II, III, IV, and V-SQ distributions. The entire Optical Module is field rotatable in 90° increments. Both module and drivers are factory wired using water resistant, insulated cord. Lens, module and drivers are field replaceable.

LED EMITTERS

High Output LED's are driven at 350mA for nominal 1 Watt output each or 525mA for nominal 1.5 Watt output each. LED's are available in standard Neutral White (4000K), or optional Cool White (5000K) or Warm White (3000K). Consult Factory for other LED options.

LED DRIVER

UL and CUL recognized High Power Factor, Constant Current LED drivers operate on input voltages from 120-277VAC, 50/60hz. Consult Factory for 347-480VAC. Driver is mechanically fastened to a retaining bracket. Main power quick disconnect provided. Driver has a minimum 4KV of internal surge protection, 10KV & 20KV Surge Protector optional. Dimming and High-Low Driver options available.

FINISH

Electrostatically applied TGIC Polyester Powder Coat on substrate prepared with 20 PSI power wash at 140°F. Four step iron phosphate pretreatment for protection and paint adhesion. 400°F bake for maximum hardness and durability. Texture finish is standard.

PROJECT NAME: _____

FIXTURE TYPE: _____

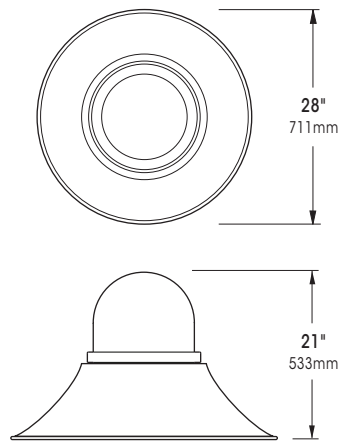

DSCP25

PATENT PENDING

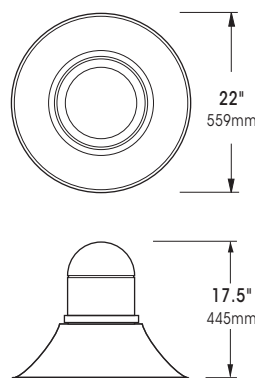

DSCP1

PATENT PENDING



2016123

DSCP SERIES - LED

S P E C I F I C A T I O N S

MOUNTING STYLES

XPD

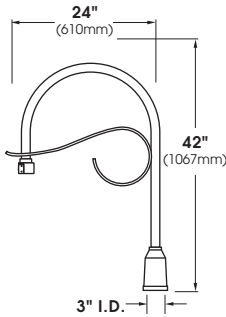

XPB

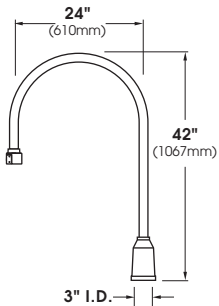

XPS

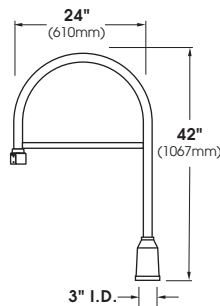

ARMS ARE HEAVY WALL EXTRUDED ALUMINUM CONSTRUCTION. FOR ADDITIONAL ARM OPTIONS SEE ARM SECTION.

WALL MOUNT

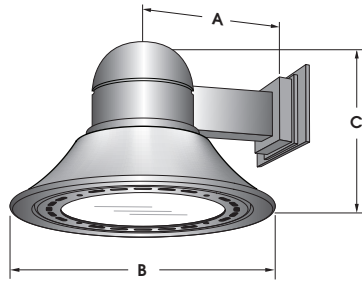

FIXTURE	A	B	C
DSCP25	18" 457mm	28" 711mm	21" 533mm
DSCP1	14" 356mm	22" 559mm	17.5" 445mm

EXTRUDED ALUMINUM ARM AND CAST ALUMINUM WALL BRACKET ASSEMBLY PROVIDED WITH BUILT IN GASKETED WIRE ACCESS FOR FIXTURE/SUPPLY WIRE CONNECTION.

WALL PLATE

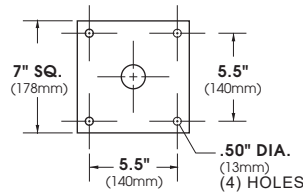

VLED® MODULES

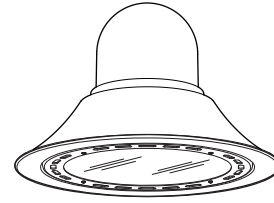

DSCP25 E.P.A. = 1.10
Available in:
120, 100, 80 & 64
LED Module

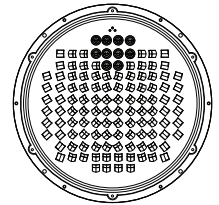

120 LED Module

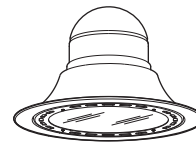

DSCP1 E.P.A. = 0.63
Available in:
80, 64 & 48
LED Module

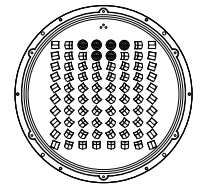

80 LED Module

MAX INPUT WATTAGE

# OF LED's	DRIVE CURRENT	350mA	525mA
120	131W	198W	
100	110W	164W	
80	91W	130W	
64	70W	105W	
48	53W	79W	

O R D E R I N G I N F O R M A T I O N

LUMINAIRE	OPTICS	# of LED's	DRIVE CURRENT	COLOR	VOLTAGE	MOUNTING	FINISH	OPTIONS
LUMINAIRE	OPTICS	LED		MOUNTING	FINISH	OPTIONS		
<input type="checkbox"/> DSCP25 <input type="checkbox"/> DSCP1	VLED® IES DISTRIBUTION TYPE <input type="checkbox"/> VLED - II (Type-II) <input type="checkbox"/> VLED - III (Type-III) <input type="checkbox"/> VLED - IV (Type-IV) <input type="checkbox"/> VLED - VSQ (Type-VSQ)	# of LED's <input type="checkbox"/> DSCP25 <input type="checkbox"/> 120LED <input type="checkbox"/> 100LED <input type="checkbox"/> 80LED <input type="checkbox"/> 64LED <hr/> <input type="checkbox"/> DSCP1 <input type="checkbox"/> 80LED <input type="checkbox"/> 64LED <input type="checkbox"/> 48LED	DRIVE CURRENT <input type="checkbox"/> 350mA <input type="checkbox"/> 525mA	COLOR <input type="checkbox"/> NW (4000K) *STANDARD <input type="checkbox"/> CW (5000K) <input type="checkbox"/> WW (3000K) OTHER LED COLORS AVAILABLE CONSULT FACTORY VOLTAGE <input type="checkbox"/> 120 <input type="checkbox"/> 208 <input type="checkbox"/> 240 <input type="checkbox"/> 277 <input type="checkbox"/> 347 <input type="checkbox"/> 480	ARM MOUNT <input type="checkbox"/> XPD <input type="checkbox"/> XPS <input type="checkbox"/> 1 WALLMOUNT <input type="checkbox"/> WM	STANDARD TEXTURED FINISH <input type="checkbox"/> BLACK RAL-9005-T <input type="checkbox"/> WHITE RAL-9003-T <input type="checkbox"/> GREY RAL-7004-T <input type="checkbox"/> DARK BRONZE RAL-8019-T <input type="checkbox"/> GREEN RAL-6005-T FOR SMOOTH FINISH REMOVE SUFFIX "T" (EXAMPLE: RAL-9500) SEE USALTG.COM FOR ADDITIONAL COLORS	<input type="checkbox"/> INTERNAL HOUSE SIDE SHIELDS... HS <input type="checkbox"/> EXTERNAL HOUSE SIDE SHIELD... EHS <input type="checkbox"/> DIMMABLE DRIVER(S) (0-10V)... DIM <input type="checkbox"/> HIGH-LOW DIMMING FOR HARDWIRED SWITCHING OR NON-INTEGRATED MOTION SENSOR... HLSW <input type="checkbox"/> PHOTO CELL + VOLTAGE (EXAMPLE: PC120V)... PC+V <input type="checkbox"/> 10KV SURGE PROTECTOR... 10SP <input type="checkbox"/> 20KV SURGE PROTECTOR (277V & 480V Only)... 20SP	