

H.I.D. AREA LIGHTING

DSDP SERIES-HID

SPECIFICATIONS

HOUSING

(For up to 175W) – Ballast housing is spun from .080" aluminum. Internal ballast support bracket also functions as mounting reinforcement plate and has a minimum thickness of .125".

(For 250W & above) – Ballast housing is cast from low copper (A356, <0.2%) aluminum alloy, minimum .125" wall thickness. Optical housing is spun from .080" aluminum, hemmed at the edges. Lens frame is a one-piece .060" aluminum spinning surrounding a 3/16" tempered glass lens sealed with a continuous silicone gasket and attaches to the housing with the Accuhinge™ hinging mechanism. A captive stainless steel thumbscrew allows for tool less entry to the optical compartment which is sealed with a closed cell E.P.D.M. gasket.

MOUNTING

When pendant mounted, the fixture housing is connected to the mounting arm by the Trulevel swivel which is internally welded to the housing and allows for fixture leveling prior to locking the swivel. When side arm mounted, the housing is externally welded to the mounting arm and the weld is blended to produce a smooth, continuous joint.

REFLECTOR MODULE

Specular Alzak® optical segments rigidly mounted in an aluminum frame, which attaches to the housing as a one piece module. Reflector module is field rotatable in 90° increments. Reflector modules are factory prewired with a quick-disconnect plug. Sockets are porcelain 4KV pulse rated, medium base (E26) for 50W – 150W or bi-pin (G12) for 70W and 150W; pin oriented mogul base (E39) for 250W – 400W. Special for 210W and 315W CDM Elite lamp base is PGZ18. Lamp is vertically or horizontally mounted.

ELECTRICAL COMPONENTS

All electrical components are UL and cUL recognized mounted on a single plate and factory wired with quick-disconnect. Electrical module attaches to housing with toolless hinge and latch. Electronic MH ballasts have power factor of >.95, -20°F starting, 120-277V 50Hz/60Hz and have lamp End-of-life protection. Special for Philips MasterColor CDM Elite: Electronic MH ballast has a power factor of >.90 (210W & 315W), -4°F starting, 200 - 277V, 50Hz/60Hz and has lamp End-of-life protection. 315W electronic MH ballast has 0 - 10V dimming capability. Magnetic MH ballasts are high power factor (70W - 150W) or CWA (250W), -20°F starting, multi-tap 120-277V, 60Hz. All HPS ballasts are core and coil, high-reactance, high power factor (70W - 150W) or CWA (200W - 400W), -40°F starting.

FINISH

Electrostatically applied TGIC Polyester Powder Coat on substrate prepared with 20 PSI power wash at 140° F. Four step iron phosphate pretreatment for protection and paint adhesion. 400°F bake for maximum hardness and durability. Texture finish is standard.

PROJECT NAME: _____

FIXTURE TYPE: _____

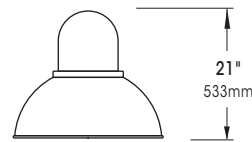
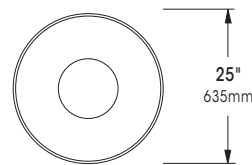

DSDP 25

PATENT PENDING

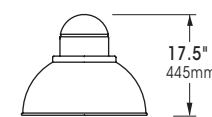
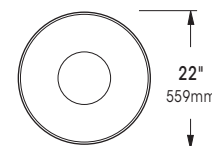

DSDP 1

PATENT PENDING

 Light Pollution Control Classification System
Full cutoff 0% Uplight Luminaire

 U.L. Listed for wet location

MADE IN THE

2014233

U.S. Architectural Lighting

660 West Avenue O, Palmdale, CA 93551
Phone (661) 233-2000 Fax (661) 233-2001
www.usallg.com



DSDP SERIES - HID

SPECIFICATIONS

MOUNTING STYLES

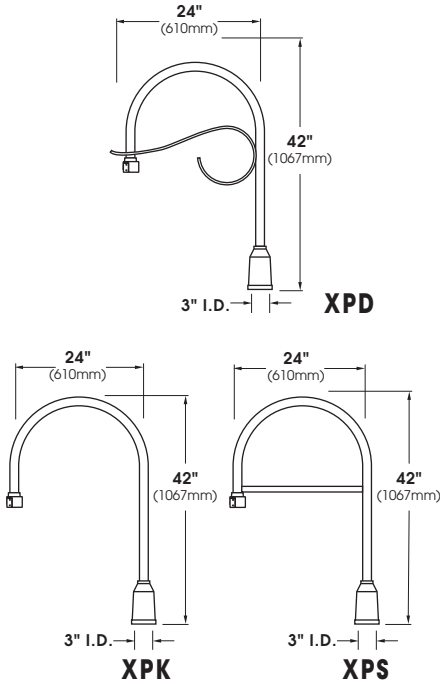

HEAVY WALL EXTRUDED ALUMINUM CONSTRUCTION.
FOR ADDITIONAL ARM OPTIONS SEE ARM SECTION.

WALL MOUNT

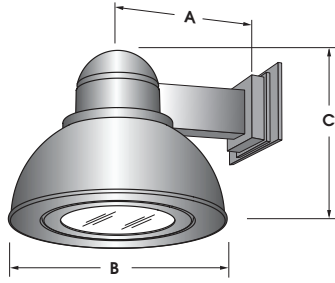

FIXTURE	A	B	C
DSDP25	18" 457mm	25" 635mm	21" 533mm
DSDP1	14" 356mm	22" 559mm	17.5" 445mm

EXTRUDED ALUMINUM ARM AND CAST ALUMINUM WALL BRACKET ASSEMBLY.

WALL PLATE

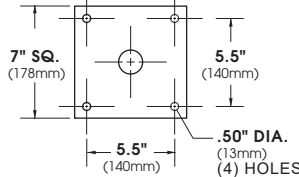

E.P.A. & LAMP WATTAGE

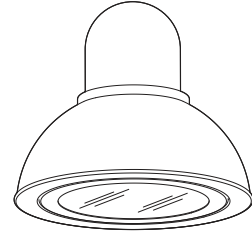

DSDP25 E.P.A. = 1.52
LAMP SIZE: 100 - 400WATT

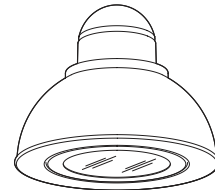

DSDP1 E.P.A. = 1.10
LAMP SIZE: 50 - 150WATT

Spec/Order Example: DSDP25/250HPS208/HR-V/1/RAL-9003/WA

SPEC / ORDERING INFORMATION

MODEL	WATTAGE	TYPE	VOLTAGE	OPTICS	MOUNTING	FINISH	OPTIONS
MODEL	LAMP			OPTICS	MOUNTING	FINISH	OPTIONS
<input type="checkbox"/> DSDP25	WATTAGE <input type="checkbox"/> 400 ⁴ <input type="checkbox"/> 350 ⁴ <input type="checkbox"/> 320 ⁴ <input type="checkbox"/> 315 ⁵ <input type="checkbox"/> 250 <input type="checkbox"/> 210 ⁵ <input type="checkbox"/> 200 ³ <input type="checkbox"/> 175 ³ <input type="checkbox"/> 150T ² <input type="checkbox"/> 150 <input type="checkbox"/> 100 <input type="checkbox"/> E ¹ (ELECTRONIC)	TYPE <input type="checkbox"/> PSMH <input type="checkbox"/> HPS	VOLTAGE <input type="checkbox"/> 120 <input type="checkbox"/> 208 <input type="checkbox"/> 240 <input type="checkbox"/> 277 <input type="checkbox"/> 347 (CAN) <input type="checkbox"/> 480	HORIZONTAL SEGMENTED REFLECTORS <input type="checkbox"/> TYPE II HR- II <input type="checkbox"/> TYPE III HR- III <input type="checkbox"/> TYPE IV HR- IV <input type="checkbox"/> FORWARD THROW (HOUSE SIDE CUT-OFF) HR- FT-HSC <input type="checkbox"/> TYPE V HR- V-SQ	ARM MOUNT <input type="checkbox"/> XPK <input type="checkbox"/> XPS <input type="checkbox"/> XPD FOR ADDITIONAL DECORATIVE ARM SELECTIONS, PLEASE REFER TO USALTG.COM ARM MOUNT <input type="checkbox"/> 1 <input type="checkbox"/> 2-180 <input type="checkbox"/> 3-120 <input type="checkbox"/> 4-90	STANDARD TEXTURED FINISH <input type="checkbox"/> BLACK RAL-9005-T <input type="checkbox"/> WHITE RAL-9003-T <input type="checkbox"/> GREY RAL-7004-T <input type="checkbox"/> DARK BRONZE RAL-8019-T <input type="checkbox"/> GREEN RAL-6005-T	<input type="checkbox"/> CONVEX GLASS LENS DG <input type="checkbox"/> CLEAR ACRYLIC CONVEX LENS (175W MAX.) CA <input type="checkbox"/> CLEAR POLYCARBONATE CONVEX LENS (175W MAX.) CP <input type="checkbox"/> OPAL ACRYLIC CONVEX LENS (175W MAX.) WA <input type="checkbox"/> OPAL POLYCARBONATE CONVEX LENS (175W MAX.) WP <input type="checkbox"/> 3/4" IPS STEM MOUNT AND SWIVEL CANOPY (4'-0" MAX.) SM <input type="checkbox"/> CHAIN MOUNTED (4'-0" MAX.) CM <input type="checkbox"/> HOUSE SIDE SHIELD HS <input type="checkbox"/> PHOTO CELL + VOLTAGE (EXAMPLE: PC120V) PC+V <input type="checkbox"/> SINGLE FUSE (120V, 277V) SF <input type="checkbox"/> DOUBLE FUSE (208V, 480V) DF
<input type="checkbox"/> DSDP1	WATTAGE <input type="checkbox"/> 150T ² <input type="checkbox"/> 150 <input type="checkbox"/> 100 <input type="checkbox"/> 70T ² <input type="checkbox"/> 70 <input type="checkbox"/> 50 <input type="checkbox"/> E ¹ (ELECTRONIC)	TYPE <input type="checkbox"/> PSMH <input type="checkbox"/> HPS	VOLTAGE <input type="checkbox"/> 120 <input type="checkbox"/> 208 <input type="checkbox"/> 240 <input type="checkbox"/> 277 <input type="checkbox"/> 347 (CAN) <input type="checkbox"/> 480	VERTICAL SEGMENTED REFLECTORS <input type="checkbox"/> ASYMMETRIC VR- ASY <input type="checkbox"/> SYMMETRIC VR- SYM	WALLMOUNT <input type="checkbox"/> WM	FOR SMOOTH FINISH REPLACE SUFFIX "T" WITH SUFFIX "S" (EXAMPLE: RAL-9500-S) SEE USALTG.COM FOR ADDITIONAL COLORS	

CONSULT FACTORY FOR OTHER BALLAST CONFIGURATIONS AND LAMP OPTIONS

NOTES:
1 - 120-277V ONLY
2 - G12 BASE
3 - POSITION SENSITIVE LAMP
4 - "E" BALLAST NOT AVAILABLE
5 - PGZ18 BASE