

SOLID STATE AREA LIGHTING

DSDPL SERIES - PLED

FEATURES

Luminaire

Upper housing is heavy gauge cast aluminum (min. .125" wall; alloy >0.2% Cu for DSDPL25) or spun aluminum with reveal (.125" min. wall for DSDPL22). Lower housing is 0.080" thick spun aluminum with integrated LED module seat. Lower housing is vented at top and bottom for convective cooling of LED module. Top Driver chamber is barriered from LED Module chamber. Truelevel ball coupling mount is welded to housing and facilitates quick leveling and installation. Upper Housing with lit windows. LED Optic provides soft glow from diffuse windows. Circuited separately from main optical module.

PLED™ Optics

Emitters (LED's) are arrayed on a metal core PCB panel with each emitter located on a copper thermal transfer pad and enclosed by an LED refractor. LED optics completely seal each individual emitter to meet an IP66 rating. In asymmetric distributions, a micro-reflector inside the refractor re-directs the house side emitter output towards the street side and functions as a house side shielding element. Refractors are injection molded H12 acrylic. Each LED refractor is sealed to the PCB over an emitter and all refractors are retained by an aluminum frame. Any one Panel, or group of Panels in a luminaire, have the same optical pattern. LED refractors produce standard site/area distributions. Panels are field replaceable and field rotatable in 90° increments.

LED Emitters

High output LED's are utilized with drive currents ranging from 350mA to 875mA. 70CRI Minimum. LED's are available in standard Neutral White (4000K), or optional Cool White (5000K) or Warm White (3000K). Consult Factory for other LED options.

LED Driver

Constant current electronic with a power factor of >.90 and a minimum operating temperature of -40°F/-40°C. Driver(s) is/are UL and cUL recognized. In-line terminal blocks facilitate wiring between the driver and optical arrays. Drivers accept an input of 120-277V, 50/60Hz or 347V-480V, 50,60Hz. (0 - 10V dimmable driver is standard. Driver has a minimum of 3KV internal surge protection. Luminaire supplied with 20KV surge protector for field installation.)

Amber LED's

PCA (Phosphor Converted Amber) LED's utilize phosphors to create color output similar to LPS lamps and have a slight output in the blue spectral bandwidth. TRA (True Amber) LED's utilize material that emits light in the amber spectral bandwidth only without the use of phosphors.

Finish

Polyester powder coat incorporates four step iron phosphate process to pretreat metal surface for maximum adhesion. Top coat is baked at 400°F for maximum hardness and exterior durability.

PROJECT NAME: _____

FIXTURE TYPE: _____

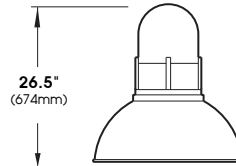
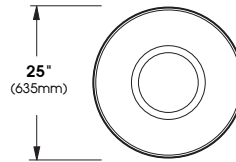

DSDPL25

Patent pending

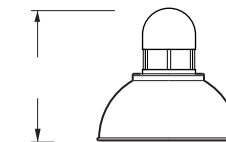

DSDPL22

(Formerly DSDPL1)

Patent pending

DSDPL SERIES - PLED

SPECIFICATIONS

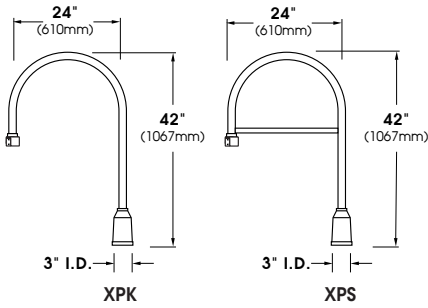
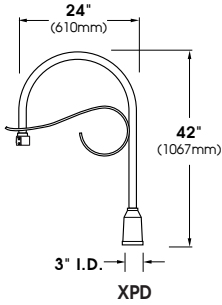

Arms are heavy wall extruded aluminum construction. For additional arm options see arm section.

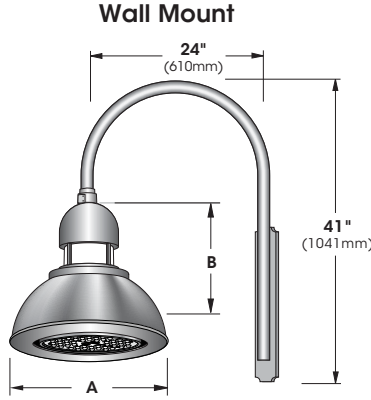

Fixture	A	B
DSDPLL25	25" (635mm)	26.5" (674mm)
DSDPLL22	22" (559mm)	20" (508mm)

Extruded and cast aluminum construction.

Wall Plate

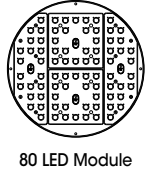
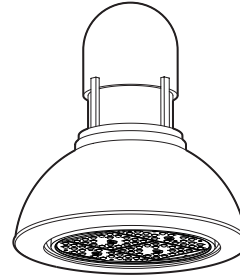
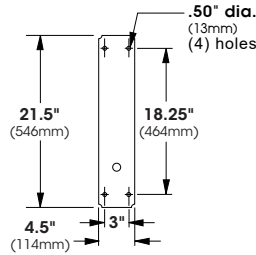

80 LED Module

DSDPL25 E.P.A. = 1.80
Available in:
80 LED Module Max

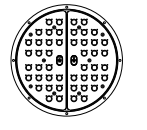

48 LED Module

DSDPL22 E.P.A. = 1.19
Available in:
48 LED Module Max

ORDERING INFORMATION

Spec/Order Example: DSDPL25/PLED-IV-FT/48LED-525mA/CW/480/1/RAL-7004-T

Luminaire	Optics	LED Mode			Voltage	Mounting	Finish	Options
Luminaire	Optics	LED			Voltage	Mounting	Finish	Options
<input type="checkbox"/> DSDPL25-PLED <input type="checkbox"/> DSDPL22-PLED (Formerly DSDPL1)	PLED™ Distribution Type <input type="checkbox"/> Type II PLED-II <input type="checkbox"/> Type II Front Row PLED-II-FR <input type="checkbox"/> Type III Med. PLED-III-M <input type="checkbox"/> Type III Wide PLED-III-W <input type="checkbox"/> Type IV PLED-IV <input type="checkbox"/> Type IV PLED-IV-FT <input type="checkbox"/> Type V Narrow PLED-V-SQ-N <input type="checkbox"/> Type V Med. PLED-V-SQ-M <input type="checkbox"/> Type V Wide PLED-V-SQ-W	# of LEDs DSDPL25 <input type="checkbox"/> 80LED ¹ <input type="checkbox"/> 48LED <input type="checkbox"/> 36LED DSDPL22 <input type="checkbox"/> 48LED ¹ <input type="checkbox"/> 36LED <input type="checkbox"/> 20LED	Drive Current <input type="checkbox"/> 1050mA ² <input type="checkbox"/> 875mA ² <input type="checkbox"/> 700mA ² <input type="checkbox"/> 525mA <input type="checkbox"/> 350mA	Color Temp - CCT <input type="checkbox"/> NW (4000K)* *Standard <input type="checkbox"/> CW (5000K) <input type="checkbox"/> WW (3000K) Other LED Colors Available Consult Factory <input type="checkbox"/> Amber ³ <input type="checkbox"/> Phosphor Converted Amber PCA ⁴ <input type="checkbox"/> True Amber ⁵ TRA	<input type="checkbox"/> 120 <input type="checkbox"/> 208 <input type="checkbox"/> 240 <input type="checkbox"/> 277 <input type="checkbox"/> 347 <input type="checkbox"/> 480	<input type="checkbox"/> XPK <input type="checkbox"/> XPS <input type="checkbox"/> XPD <input type="checkbox"/> I Wallmount <input type="checkbox"/> WM	Standard Textured Finish <input type="checkbox"/> Black RAL-9005-T <input type="checkbox"/> White RAL-9003-T <input type="checkbox"/> Grey RAL-7004-T <input type="checkbox"/> Dark Bronze RAL-8019-T <input type="checkbox"/> Green RAL-6005-T For smooth finish replace suffix "T" with suffix "S" (Example: RAL-9500-S) Consult factor for custom colors	<input type="checkbox"/> Stem Mount + Length(in) (48" Max) SM+L <input type="checkbox"/> Chain Mount + Length(in) (48" Max) CM+L <input type="checkbox"/> Internal House Side Shield inc. LED Count (Example: HS-PLED/48) HS-PLED <input type="checkbox"/> Twist Lock Receptable Only TPR <input type="checkbox"/> 7-Pin Twist Lock Receptable Only TPR7 <input type="checkbox"/> High-Low Dimming for Switch by Others/Select Levels 50/100 or 25/100 (Example: HLSW/25) HLSW <input type="checkbox"/> Photo Cell + Voltage (Example: PC120V) PC+V <input type="checkbox"/> Single Fuse (120V, 277V) SF <input type="checkbox"/> Double Fuse (208V, 240V) DF <input type="checkbox"/> Programmable Photo/Motion Sensor (Factory - Motion 50/100; Photo 75c) MS-F211 <input type="checkbox"/> Remote Motion Sensor Configurator MS-FC10



DSDPL SERIES - PLED

LED/ Electrical Guide (pg. 1)

LED Count	Source Type	Source	Initial Lumens - 4000K CCT	Initial Lumens - 3000K CCT	Initial Lumens - 5000K CCT	L70 greater than (HR)	Starting Temp.	System Watts	Volts	Max Input Amps
DSDPL22										
20	LED	20 PLED® Optical Module - 350mA	2842 - 3262	2700 - 3098	2984 - 3424	90,000+	-40°F	22/28	120 277 347	.19/.24 .08/.11 .07/.08
20	LED	20 PLED® Optical Module - 525mA	4042 - 4637	3839 - 4405	4243 - 4868	90,000+	-40°F	33/39	120 277 347	.28/.33 .12/.14 .10/.12
20	LED	20 PLED® Optical Module - 700mA	5083 - 5832	4829 - 5540	5337 - 6123	90,000+	-40°F	44/50	120 277 347	.37/.42 .16/.18 .13/.15
20	LED	20 PLED® Optical Module - 875mA	6108 - 7008	5802 - 6657	6413 - 7358	90,000+	-40°F	56/62	120 277 347	.47/.52 .21/.23 .17/.18
20	LED	20 PLED® Optical Module - 1050mA	7086 - 8131	6732 - 7725	7441 - 8537	90,000+	-40°F	67/73	120 277 347	.56/.61 .25/.27 .20/.21
36	LED	36 PLED® Optical Module - 350mA	5116 - 5871	4860 - 5577	5371 - 6164	90,000+	-40°F	40/46	120 277 347	.34/.39 .15/.17 .12/.14
36	LED	36 PLED® Optical Module - 525mA	7274 - 8346	6910 - 7929	7638 - 8763	90,000+	-40°F	60/66	120 277 347	.50/.55 .22/.24 .18/.20
36	LED	36 PLED® Optical Module - 700mA	9149 - 10497	8691 - 9972	9606 - 11022	90,000+	-40°F	79/85	120 277 347	.66/.71 .29/.31 .23/.25
36	LED	36 PLED® Optical Module - 875mA	10994 - 12614	10444 - 11983	11544 - 13245	90,000+	-40°F	101/107	120 277 347	.85/.90 .37/.39 .30/.31
36	LED	36 PLED® Optical Module - 1050mA	12755 - 14635	12117 - 13903	13392 - 15367	90,000+	-40°F	120/126	120 277 347	1.00/1.05 .44/.46 .35/.37
48	LED	48 PLED® Optical Module - 350mA	6821 - 7827	6480 - 7435	7162 - 8218	90,000+	-40°F	53/59	120 277 347	.45/.50 .20/.22 .16/.17
48	LED	48 PLED® Optical Module - 525mA	9699 - 11128	9214 - 10572	10183 - 11684	90,000+	-40°F	79/85	120 277 347	.66/.71 .29/.31 .23/.25
48	LED	48 PLED® Optical Module - 700mA	12199 - 13398	11589 - 13296	12808 - 14696	90,000+	-40°F	106/112	120 277 347	.89/.94 .39/.41 .31/.33
48	LED	48 PLED® Optical Module - 875mA	14659 - 16819	13926 - 15978	15392 - 17660	90,000+	-40°F	134/140	120 277 347	1.12/1.17 .49/.51 .39/.41
DSDPL25										
36	LED	36 PLED® Optical Module - 350mA	5126 - 5882	4870 - 5588	5383 - 6176	90,000+	-40°F	40/46	120 277 347	.34/.39 .15/.17 .12/.14
36	LED	36 PLED® Optical Module - 525mA	7382 - 8470	7013 - 8047	7751 - 8894	90,000+	-40°F	59/65	120 277 347	.50/.55 .23/.24 .17/.19
36	LED	36 PLED® Optical Module - 700mA	9362 - 10742	8894 - 10205	9830 - 11279	90,000+	-40°F	79/85	120 277 347	.66/.71 .29/.31 .23/.25
36	LED	36 PLED® Optical Module - 875mA	10719 - 12298	10183 - 11682	11254 - 12913	90,000+	-40°F	103/109	120 277 347	.86/.91 .38/.40 .30/.32
36	LED	36 PLED® Optical Module - 1050mA	12435 - 14268	11813 - 13554	13057 - 14981	90,000+	-40°F	116/122	120 277 347	.97/1.02 .42/.44 .34/.36
48	LED	48 PLED® Optical Module - 350mA	6835 - 7843	6493 - 7450	7177 - 8235	90,000+	-40°F	53/59	120 277 347	.45/.50 .20/.23 .16/.17



DSDPL SERIES - PLED

LED/ Electrical Guide (pg. 2)

LED Count	Source Type	Source	Initial Lumens - 4000K CCT	Initial Lumens - 3000K CCT	Initial Lumens - 5000K CCT	L70 greater than (HR)	Starting Temp.	System Watts	Volts	Max Input Amps
DSDPL25										
48	LED	48 PLED® Optical Module - 525mA	9843 - 11294	9351 - 10729	10336 - 11859	90,000+	-40°F	78/84	120 277 347	.65/.70 .29/.31 .23/.25
48	LED	48 PLED® Optical Module - 700mA	12483 - 14323	11859 - 13607	13107 - 15038	90,000+	-40°F	105/111	120 277 347	.88/.93 .38/.40 .31/.32
48	LED	48 PLED® Optical Module - 875mA	14292 - 16397	13577 - 15577	15006 - 17217	90,000+	-40°F	137/143	120 277 347	1.15/1.20 .50/.52 .40/.42
48	LED	48 PLED® Optical Module - 1050mA	16581 - 19024	15752 - 18073	17409 - 19975	90,000+	-40°F	154/160	120 277 347	1.29/1.34 .56/.58 .45/.47
80	LED	80 PLED® Optical Module - 350mA	11392 - 13071	10823 - 12418	11962 - 13724	90,000+	-40°F	88/94	120 277 347	.74/.79 .32/.34 .26/.27
80	LED	80 PLED® Optical Module - 525mA	16406 - 18823	15585 - 17882	17226 - 19765	90,000+	-40°F	130/136	120 277 347	1.09/1.14 .47/.50 .38/.40
80	LED	80 PLED® Optical Module - 700mA	20805 - 23871	19765 - 22678	21845 - 25065	90,000+	-40°F	174/180	120 277 347	1.45/1.50 .63/.65 .50/.52
80	LED	80 PLED® Optical Module - 875mA	23819 - 27329	22628 - 25962	25010 - 28695	90,000+	-40°F	226/232	120 277 347	1.89/1.94 .82/.84 .66/.69

Phosphor Converted Amber LED

DSDPL22

20	PCA - LED	20 PLED® Optical Module - 350mA	1478 - 1696			51,000+	-40°F	25	120 277 347	.21 .10 .08
20	PCA - LED	20 PLED® Optical Module - 525mA	2102 - 2411			51,000+	-40°F	37	120 277 347	.31 .14 .11
20	PCA - LED	20 PLED® Optical Module - 700mA	2643 - 3033			51,000+	-40°F	50	120 277 347	.42 .18 .15
36	PCA - LED	36 PLED® Optical Module - 350mA	2660 - 3053			51,000+	-40°F	45	120 277 347	.38 .17 .13
36	PCA - LED	36 PLED® Optical Module - 525mA	3783 - 4340			51,000+	-40°F	67	120 277 347	.56 .25 .20
36	PCA - LED	36 PLED® Optical Module - 700mA	4757 - 5459			51,000+	-40°F	89	120 277 347	.75 .33 .26
48	PCA - LED	48 PLED® Optical Module - 350mA	3547 - 4070			51,000+	-40°F	59	120 277 347	.50 .22 .17
48	PCA - LED	48 PLED® Optical Module - 525mA	5043 - 5787			51,000+	-40°F	89	120 277 347	.75 .33 .26
48	PCA - LED	48 PLED® Optical Module - 700mA	6343 - 7278			51,000+	-40°F	118	120 277 347	.99 .43 .34

DSDPL25

36	PCA - LED	36 PLED® Optical Module - 350mA	2666 - 3059			51,000+	-40°F	45	120 277 347	.38 .17 .13
36	PCA - LED	36 PLED® Optical Module - 525mA	3839 - 4405			51,000+	-40°F	66	120 277 347	.56 .24 .19



DSDPL SERIES - PLED

LED Count	Source Type	Source	Initial Lumens - 4000K CCT	Initial Lumens - 3000K CCT	Initial Lumens - 5000K CCT	L70 greater than (HR)	Starting Temp.	System Watts	Volts	Max Input Amps
-----------	-------------	--------	----------------------------	----------------------------	----------------------------	-----------------------	----------------	--------------	-------	----------------

Phosphor Converted Amber LED

DSDPL25

36	PCA - LED	36 PLED® Optical Module - 700mA	4868 - 5586			51,000+	-40°F	88	120	.74
									277	.32
									347	.26
48	PCA - LED	48 PLED® Optical Module - 350mA	3554 - 4078			51,000+	-40°F	59	120	.50
									277	.22
									347	.17
48	PCA - LED	48 PLED® Optical Module - 525mA	5119 - 5873			51,000+	-40°F	87	120	.73
									277	.32
									347	.25
48	PCA - LED	48 PLED® Optical Module - 700mA	6491 - 7448			51,000+	-40°F	117	120	.98
									277	.43
									347	.34
80	PCA - LED	80 PLED® Optical Module - 350mA	11392 - 13071			51,000+	-40°F	98	120	.82
									277	.36
									347	.29
80	PCA - LED	80 PLED® Optical Module - 525mA	16406 - 18823			51,000+	-40°F	145	120	1.21
									277	.52
									347	.42
80	PCA - LED	80 PLED® Optical Module - 700mA	20805 - 23871			51,000+	-40°F	195	120	1.63
									277	.71
									347	.57

True Amber LED - 590nm

DSDPL22

20	TRA - LED	20 PLED® Optical Module - 350mA	854 - 979			66,500+	-40°F	18	120	.15
									277	.07
									347	.06
20	TRA - LED	20 PLED® Optical Module - 700mA	1022 - 1172			66,500+	-40°F	26	120	.22
									277	.10
									347	.08
36	TRA - LED	36 PLED® Optical Module - 350mA	1536 - 1762			66,500+	-40°F	31	120	.26
									277	.12
									347	.09
36	TRA - LED	36 PLED® Optical Module - 525mA	1838 - 2109			66,500+	-40°F	47	120	.40
									277	.17
									347	.14
48	TRA - LED	48 PLED® Optical Module - 350mA	2048 - 2350			66,500+	-40°F	41	120	.35
									277	.15
									347	.12
48	TRA - LED	48 PLED® Optical Module - 525mA	2451 - 2812			66,500+	-40°F	62	120	.52
									277	.23
									347	.18

DSDPL25

36	TRA - LED	36 PLED® Optical Module - 350mA	1539 - 1766			66,500+	-40°F	31	120	.26
									277	.12
									347	.09
36	TRA - LED	36 PLED® Optical Module - 525mA	1866 - 2140			66,500+	-40°F	46	120	.39
									277	.18
									347	.14
48	TRA - LED	48 PLED® Optical Module - 350mA	2053 - 2355			66,500+	-40°F	41	120	.35
									277	.19
									347	.12
48	TRA - LED	48 PLED® Optical Module - 525mA	2488 - 2854			66,500+	-40°F	61	120	.51
									277	.22
									347	.18
80	TRA - LED	80 PLED® Optical Module - 350mA	3421 - 3925			66,500+	-40°F	67	120	.56
									277	.25
									347	.20



DSDPL SERIES - PLED

LED Count	Source Type	Source	Initial Lumens - 4000K CCT	Initial Lumens - 3000K CCT	Initial Lumens - 5000K CCT	L70 greater than (HR)	Starting Temp.	System Watts	Volts	Max Input Amps
True Amber LED - 590nm										

DSDPL25

80	TRA - LED	80 PLED® Optical Module - 525mA	4146 - 4757	66,500+	-40°F	101	120	.85
							277	.37
							347	.30

- 1) Max Input Amps is the highest of starting, operating, or open circuit currents
- 2) System Watts includes the source watts and all driver components.
- 3) Lumen values for LED Modules vary according to the distribution type
- 4) For Wattage and Max Input Amps showing two values, use the higher value for luminaires with lit uplight windows (-L & -M)
- 5) PCA and TRA LED optics not recommended for use with lit uplight window models (-L & -M)
- 6) Fuse value should be sufficient to protect all wiring components. For electronic driver and LED component protection, use 20KV surge suppressors.
- 7) L70(10K) – TM-21 6x rule applied

WARNING: All fixtures must be installed in accordance with local codes or the National Electrical Code. Failure to do so may result in serious personal injury.

