

SOLID STATE AREA LIGHTING

DSTR SERIES-LED

SPECIFICATIONS

LUMINAIRE

Upper housing is 0.125" thick formed aluminum (DSTR1) or heavy wall cast aluminum (DSTR25). Lower housing is 0.080" thick formed aluminum. Closed bottom polycarbonate prismatic refracting lens. Pendant Mount uses Trulevel ball coupling mount. Wall mount has integrated side mount extruded aluminum arm and cast aluminum wall plate. All hardware is stainless steel.

LED POWER ARRAY™

Three-dimensional array of individual LED Tubes fastened to a retaining plate. Each LED Tube consists of circuit board populated with a multiple of LED's and is mechanically fastened to a radial aluminum heat sink. An acrylic lens and end cap protects the LED Tube's internal components.

VERTICAL POWER ARRAY™ WITH REFRACTING LENS: LED

Tubes are aligned vertically and arranged radially to produce an even raw light distribution that simulates standard light sources. Used in conjunction with the external prismatic refracting which provides the optical control.

LED EMITTERS

High Output LED's are driven at 350mA for nominal 1 Watt output each. LED's are available in standard Neutral White (4000K), or optional Cool White (5000K) or Warm White (3000K). Consult Factory for other LED options.

LED DRIVER

UL and CUL recognized High Power Factor, Constant Current LED drivers operate on input voltages from 120-277VAC, 50/60hz. Consult Factory for 347-480VAC. Driver is mechanically fastened to a retaining bracket. Main power quick disconnect provided. Driver has a minimum 4KV of internal surge protection, 10KV & 20KV Surge Protector optional. Dimming and High-Low Driver options available.

FINISH

Polyester powder coat incorporates four step iron phosphate process to pretreat metal surface for maximum adhesion. Top coat is baked at 400°F for maximum hardness and exterior durability.

PROJECT NAME: _____

FIXTURE TYPE: _____



DSTR

* DSTR1 SHOWN

PATENT PENDING

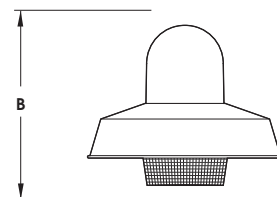
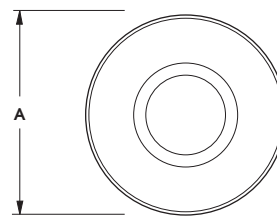

FIXTURE	A	B
DSTR25	25" 635mm	20" 508mm
DSTR1	20" 508mm	16.5" 419mm



2013140

DSTR SERIES - LED

S P E C I F I C A T I O N S

MOUNTING STYLES

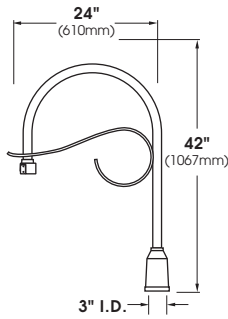

XPD

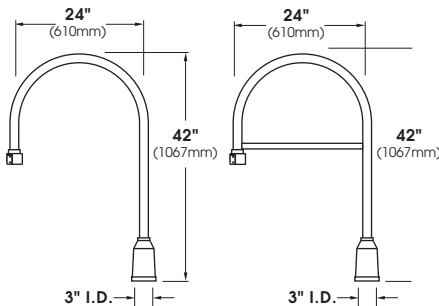

XPK

XPS

ARMS ARE HEAVY WALL EXTRUDED ALUMINUM CONSTRUCTION. FOR ADDITIONAL ARM OPTIONS SEE ARM SECTION.

WALL MOUNT

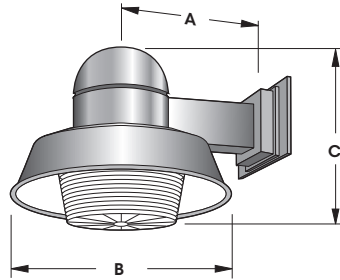

FIXTURE	A	B	C
DSTR25	18" 457mm	25" 635mm	20" 508mm
DSTR1	14" 356mm	20" 508mm	16.5" 419mm

EXTRUDED ALUMINUM ARM AND CAST ALUMINUM WALL BRACKET ASSEMBLY PROVIDED WITH BUILT IN GASKETED WIRE ACCESS FOR FIXTURE/SUPPLY WIRE CONNECTION.

WALL PLATE

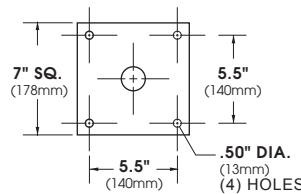

LED POWER ARRAY™ MODULES

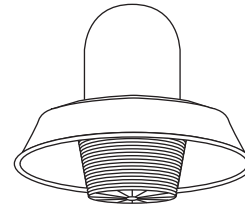

DSTR25 E.P.A. = 1.32

Available in:
80 LED Module Max



VPA - Vertical Array
Top Mount

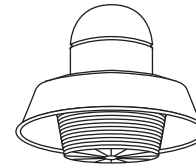

DSTR1 E.P.A. = 0.86

Available in:
64 LED Module Max

(Specifications subject to change without prior notice.)

O R D E R I N G I N F O R M A T I O N

LUMINAIRE-FITTER	OPTICS	# of LED's	COLOR	VOLTAGE	MOUNTING	FINISH	OPTIONS
LUMINAIRE	OPTICS	LED		MOUNTING	FINISH	OPTIONS	
LUMINAIRE-FITTER	VERTICAL POWER ARRAY (Clear Prismatic Refracting Lens)	# of LEDs	COLOR	VOLTAGE	<input type="checkbox"/> XPK <input type="checkbox"/> XPS <input type="checkbox"/> XPD	STANDARD TEXTURED FINISH	LENS OPTIONS:
<input type="checkbox"/> DSTR25-LED	<input type="checkbox"/> VPA - I	<input type="checkbox"/> 80LED (89 Watts)	<input type="checkbox"/> NW (4000K)*	<input type="checkbox"/> 120	<input type="checkbox"/> 1	<input type="checkbox"/> BLACK RAL-9005-T	<input type="checkbox"/> POLYCARBONATE REFRACTING LENS... PL (STANDARD)
<input type="checkbox"/> DSTR1-LED	<input type="checkbox"/> VPA - II	<input type="checkbox"/> 64LED (71 Watts)	<input type="checkbox"/> CW (5000K)	<input type="checkbox"/> 208	<input type="checkbox"/> WALLMOUNT	<input type="checkbox"/> WHITE RAL-9003-T	<input type="checkbox"/> ACRYLIC REFRACTING LENS... AL
	<input type="checkbox"/> VPA - III	<input type="checkbox"/> 48LED (53 Watts)	<input type="checkbox"/> WW (3000K)	<input type="checkbox"/> 240	<input type="checkbox"/> WM	<input type="checkbox"/> GREY RAL-7004-T	<input type="checkbox"/> STEM MOUNT + LENGTH(IN) (48" MAX) ... SM+L
	<input type="checkbox"/> VPA - V	<input type="checkbox"/> 36LED (41 Watts)	OTHER LED COLORS AVAILABLE CONSULT FACTORY	<input type="checkbox"/> 277		<input type="checkbox"/> DARK BRONZE RAL-8019-T	<input type="checkbox"/> CHAIN MOUNT + LENGTH(IN) (48" MAX) ... CM+L
		Wattages Are Max Input Watts		<input type="checkbox"/> 347		<input type="checkbox"/> GREEN RAL-6005-T	<input type="checkbox"/> DIMMABLE DRIVER(S) (0-10V) ... DIM
				<input type="checkbox"/> 480			<input type="checkbox"/> HIGH-LOW DIMMING FOR HARDWIRED SWITCHING OR NON-INTEGRATED MOTION SENSOR ... HLSW
							<input type="checkbox"/> PHOTO CELL + VOLTAGE (EXAMPLE: PC120V) ... PC+V
							<input type="checkbox"/> 10KV SURGE PROTECTOR ... 10SP
							<input type="checkbox"/> 20KV SURGE PROTECTOR (277V & 480V Only) ... 20SP