

(SPECIFY AS SUFFIX TO LUMINAIRE NO.)

PRISMATIC BOROSILICATE GLASS REFRACTOR PROVIDED WITH CAST ALUMINUM FITTER.

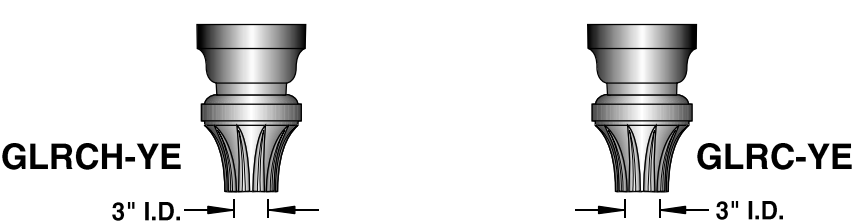

BRASS FINIAL

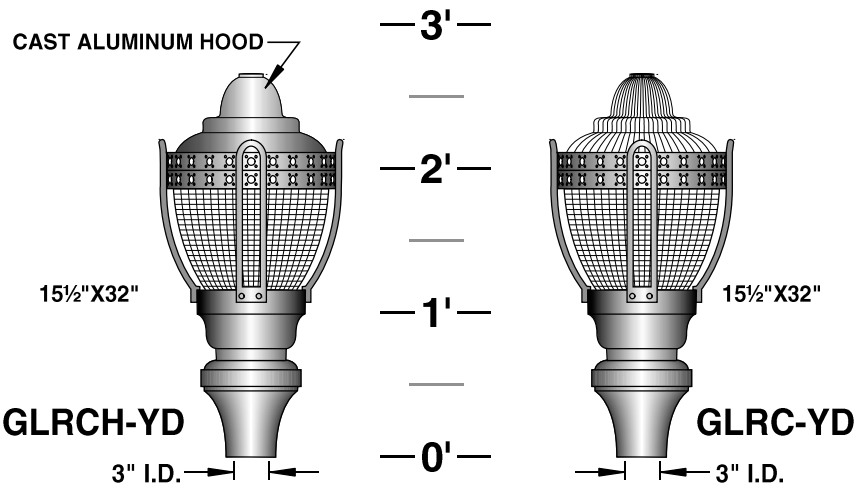

BF

ORNAMENTAL FINIAL



PF

HOUSE SIDE SHIELD
90°, 135°, 180°

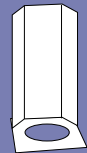

HS90°
HS135°
HS180°

BALLASTS ARE H.P.F. / C.W.A. AUTOTRANSFORMER, -20° STARTING TEMPERATURE

METAL HALIDE	HIGH PRESSURE SODIUM	MERCURY VAPOR	FOR FLUOR. LAMPS CONSULT FACTORY
50W.	50W.	50W.	INC.
70W.	70W.	75W.	TO
100W.	100W.	100W.	200W.
YD" AND "YE" FITTERS ONLY { 175W.	150W.	175W.	
250W.	250W.	250W.	



- TYPE III LIGHT DISTRIBUTION.....III
- TYPE IV LIGHT DISTRIBUTION.....IV
- TYPE V LIGHT DISTRIBUTION.....V

PHOTO CELL + VOLTAGE (EXAMPLE: PC120V).....PC+V

TWIST LOCK PHOTO CELL + VOLTAGE (EXAMPLE: TPC120V).....TPC+V (YD & YE FITTERS ONLY)

SINGLE FUSE (120V., 277V.).....SF

DOUBLE FUSE (208V., 240V., 480V.).....DF



SCALE: 1/4"=1'-0"

14
13
12
11
10
9
8
7
6
5
4
3
2
1
0

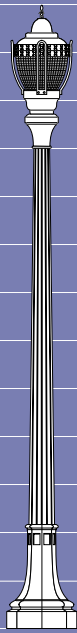

A



B



C



D

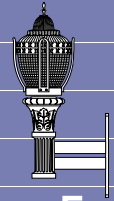

E

16
15
14
13
12
11
10
9
8
7
6
5
4
3
2
1
0

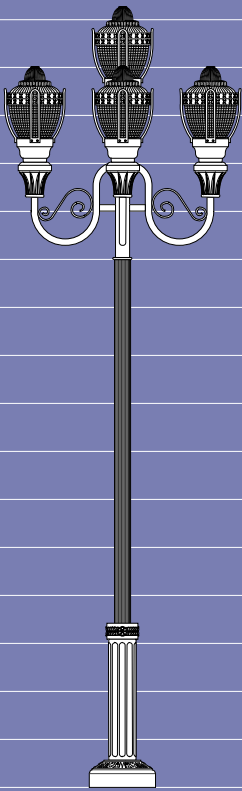

F

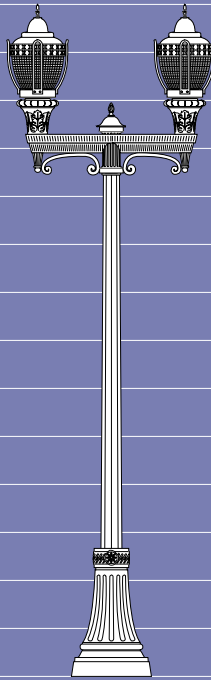

G

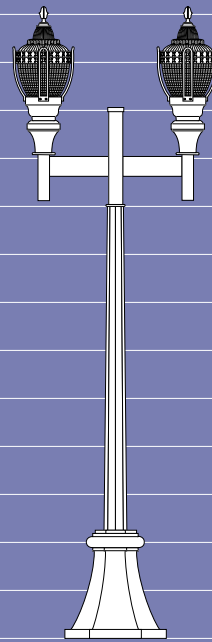

H

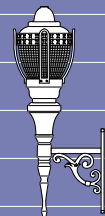

I

FT.

- A. 26-1050C-10'/GLRCH-III-BF/PT/BALLAST/ACCESSORIES/FINISH
- B. 9-1060-9'/GLRC-V/PT/BALLAST/ACCESSORIES/FINISH
- C. 19-5040-10'/GLRC-IV/PT/BALLAST/ACCESSORIES/FINISH
- D. 21-1040-11'/GLRCH-III/PT/BALLAST/ACCESSORIES/FINISH
- E. WS/GLRC-V-BF/XAV-WM/BALLAST/ACCESSORIES/FINISH

- F. 23-1060-11'/GLRC-III/XBJ-5-90/BALLAST/ACCESSORIES/FINISH
- G. 44-1058C-10'-6"/GLRCH-IV-BF/XAD-2-180/BALLAST/ACCESSORIES/FINISH
- H. 22-1080C-9'/GLRC-V-PF/XAO-2-180/BALLAST/ACCESSORIES/FINISH
- I. WS/GLRCH-III/XBD-WM/BALLAST/ACCESSORIES/FINISH