

# SOLID STATE AREA LIGHTING

# LCKM SERIES-LED

## SPECIFICATIONS

### HOUSING

Heavy cast low copper aluminum assembly (A356 alloy, <0.2% copper). Minimum wall thickness is .188". Traditional styling of the housing provided with cast aluminum housing top hinges for easy access.

### LED OPTICAL MODULE

Low copper A356 alloy (<.2% copper) cast aluminum housing. Integrated clear tempered 3/16" glass lens sealed with a continuous silicone gasket protects emitters (LED's) and emitter Reflector-Prism optics, and seals the module from water intrusion and environmental contaminants. LED's are available in standard Neutral White (4000K), or optional Cool White (5000K) or Warm White (3000K). Each emitter is optically controlled by a Reflector-Prism injection molded from H12 acrylic (3 types per module; one from 0° - 50°; one from 50° - 65°; one from 65° - 72°). Each Reflector-Prism has indexing pins for aiming and is secured to an optical plate made of matte black anodized aluminum. The optical plate locates every Reflector-Prism over an emitter. Reflector-Prisms are secured to the optical plate with a UV curing adhesive. The Reflector-Prisms are arrayed to produce IES Type II, III, IV, and V-SQ distributions. The entire Optical Module is field rotatable in 90° increments. Both module and drivers are factory wired using water resistant, insulated cord. Lens, module and drivers are field replaceable.

### LED EMITTERS

High Output LED's are driven at 350mA for nominal 1 Watt output each or 525mA for nominal 1.5 Watt output each. LED's are available in standard Neutral White (4000K), or optional Cool White (5000K) or Warm White (3000K). Consult Factory for other LED options.

### LED DRIVER

UL and CUL recognized High Power Factor, Constant Current LED drivers operate on input voltages from 120-277VAC, 50/60hz. Consult Factory for 347-480VAC. Driver is mechanically fastened to a retaining bracket. Main power quick disconnect provided. Driver has a minimum 4KV of internal surge protection, 10KV & 20KV Surge Protector optional. Dimming and High-Low Driver options available.

### FINISH

Electrostatically applied TGIC Polyester Powder Coat on substrate prepared with 20 PSI power wash at 140°F. Four step iron phosphate pretreatment for protection and paint adhesion. 400°F bake for maximum hardness and durability. Texture finish is standard.

PROJECT NAME: \_\_\_\_\_

PROJECT TYPE: \_\_\_\_\_



**LCKM**

PATENT PENDING

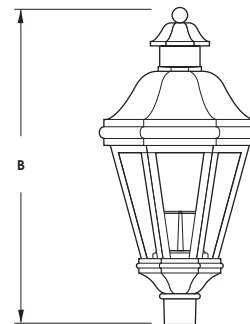
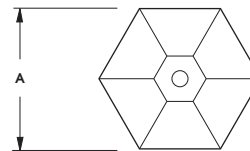

Fitter supplied to fit over 2 7/8" X 3" (73mm X 76mm) tennon.

FIXTURE	A	B
LCKM1	20.5" 521mm	40" 1016mm
LCKM2	17" 432mm	35.5" 902mm



FULL CUTOFF OPTICS  
-DARK SKY FRIENDLY-



2013347

# LCKM SERIES - LED

## S P E C I F I C A T I O N S

### MOUNTING STYLES

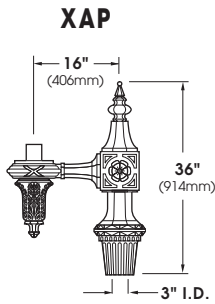
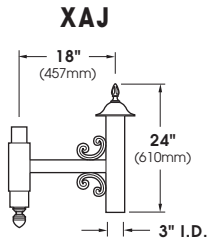
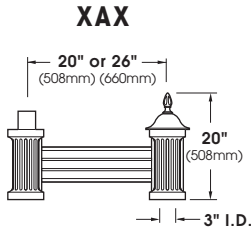

ARMS ARE HEAVY WALL EXTRUDED ALUMINUM CONSTRUCTION. FOR ADDITIONAL ARM OPTIONS SEE ARM SECTION.

### WALL MOUNT

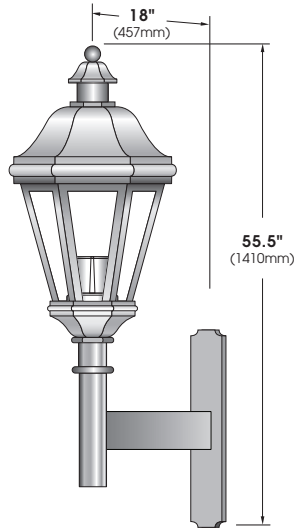

ARM BRACKET EXTRUDED AND CAST ALUMINUM CONSTRUCTION.

### WALL PLATE

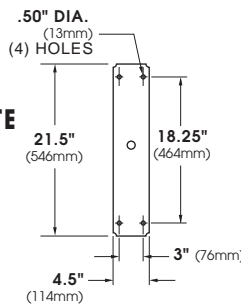

### LED<sup>®</sup> MODULES

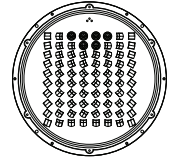
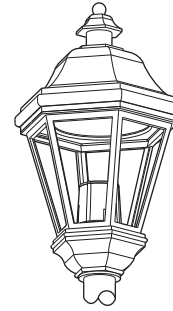

80 LED Module

**LCKM1** E.P.A. = 2.15  
Available in:  
80, 64, & 48  
LED Module

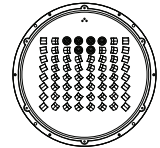

64 LED Module

**LCKM2** E.P.A. = 1.61  
Available in:  
64 & 48  
LED Module

### MAX INPUT WATTAGE

# OF LED's	DRIVE CURRENT	
	350mA	525mA
80	91W	130W
64	70W	105W
48	53W	79W

## O R D E R I N G I N F O R M A T I O N

LUMINAIRE	OPTICS	# of LED's	COLOR	VOLTAGE	MOUNTING	FINISH	OPTIONS
<b>LUMINAIRE</b>	<b>OPTICS</b>	<b>LED</b>		<b>MOUNTING</b>	<b>FINISH</b>	<b>OPTIONS</b>	
<input type="checkbox"/> LCKM1 <input type="checkbox"/> LCKM2	<b>LED<sup>®</sup></b> <b>IES DISTRIBUTION TYPE</b> <input type="checkbox"/> VLED - II (Type-II) <input type="checkbox"/> VLED - III (Type-III) <input type="checkbox"/> VLED - IV (Type-IV) <input type="checkbox"/> VLED - VSQ (Type-VSQ)	<b>No. LEDs</b> <b>LCKM1</b> <input type="checkbox"/> 80LED (89 Watts) <input type="checkbox"/> 64LED (72 Watts) <input type="checkbox"/> 48LED (53 Watts) <hr/> <b>LCKM2</b> <input type="checkbox"/> 64LED (72 Watts) <input type="checkbox"/> 48LED (53 Watts)	<input type="checkbox"/> NW (4000K) * *STANDARD <input type="checkbox"/> CW (5000K) <input type="checkbox"/> WW (3000K) OTHER LED COLORS AVAILABLE CONSULT FACTORY	<input type="checkbox"/> 120 <input type="checkbox"/> 208 <input type="checkbox"/> 240 <input type="checkbox"/> 277 <input type="checkbox"/> 347 <input type="checkbox"/> 480	<b>ARM MOUNT</b> <input type="checkbox"/> PT ..... ● <input type="checkbox"/> 1 ..... ●- <input type="checkbox"/> 2-180 ..... ●-● <input type="checkbox"/> 2-90 ..... ●-● <input type="checkbox"/> 3-90 ..... ●-●-● <input type="checkbox"/> 3-120 ..... ●-●-● <input type="checkbox"/> 4-90 ..... ●-●-●-●  <b>WALL MOUNT</b> <input type="checkbox"/> WM ..... ●	<b>STANDARD TEXTURED FINISH</b> <input type="checkbox"/> BLACK RAL-9005-T <input type="checkbox"/> WHITE RAL-9003-T <input type="checkbox"/> GREY RAL-7004-T <input type="checkbox"/> DARK BRONZE RAL-8019-T <input type="checkbox"/> GREEN RAL-6005-T  FOR SMOOTH FINISH REMOVE SUFFIX "T" (EXAMPLE: RAL-9500) SEE USALTG.COM FOR ADDITIONAL COLORS	<input type="checkbox"/> INTERNAL HOUSE SIDE SHIELDS... HS <input type="checkbox"/> EXTERNAL HOUSE SIDE SHIELD... EHS <input type="checkbox"/> DIMMABLE DRIVER(S) (0-10V)... DIM <input type="checkbox"/> HIGH-LOW DIMMING FOR HARDWIRED SWITCHING OR NON-INTEGRATED MOTION SENSOR... HLSW <input type="checkbox"/> PHOTO CELL + VOLTAGE (EXAMPLE: PC120V)... PC+V <input type="checkbox"/> 10KV SURGE PROTECTOR... 10SP <input type="checkbox"/> 20KV SURGE PROTECTOR (277V & 480V Only)... 20SP

Wattages are Max Input Watts

# SOLID STATE AREA LIGHTING

## LCKM SERIES-LED

### SPECIFICATIONS

#### LUMINAIRE

High Impact clear polycarbonate diffusing lenses provided with durable corrosion resistant cast aluminum housing. Top is hinged for access. Luminaire base has 3" I.D. opening for tenon. All hardware is stainless steel.

#### LED POWER ARRAY™

Three-dimensional array of individual LED Tubes fastened to a retaining plate. Each LED Tube consists of circuit board populated with a multiple of LED's and is mechanically fastened to a radial aluminum heat sink. An acrylic Lens and end cap protects the LED Tube's internal components.

**ANGLED POWER ARRAY™:** Micro-Reflectors mounted around each LED control the raw light output. LED Tubes are uniquely aimed horizontally and vertically and combined to produce highly efficient IES Distribution Types II, III, IV and V. Used in conjunction with a clear patterned diffusing lenses.

**VERTICAL POWER ARRAY™ WITH GLASS REFRACTOR:** LED Tubes are aligned vertically and arranged radially to produce an even raw light distribution that simulates standard light sources. Array is secured within a 6" Prismatic Glass Refractor which provides the optical control. Used in conjunction with clear smooth or clear patterned lenses.

**VERTICAL POWER ARRAY™:** LED Tubes are aligned vertically and arranged radially to produce an even raw light distribution that simulates standard light sources. Produces a minimal glare, symmetric diffuse light distribution. Used in conjunction with opal diffusing lenses.

#### LED EMITTERS

High Output LED's are driven at 350mA for nominal 1 Watt output each. LED's are available in standard Neutral White (4000K), or optional Cool White (5000K) or Warm White (3000K). Consult Factory for other LED options.

#### LED DRIVER

UL and CUL recognized High Power Factor, Constant Current LED drivers operate on input voltages from 120-277VAC, 50/60hz. Consult Factory for 347-480VAC. Driver is mechanically fastened to a retaining bracket. Main power quick disconnect provided. Driver has a minimum 4KV of internal surge protection, 10KV & 20KV Surge Protector optional. Dimming and High-Low Driver options available.

#### FINISH

Polyester powder coat incorporates four step iron phosphate process to pretreat metal surface for maximum adhesion. Top coat is baked at 400°F for maximum hardness and exterior durability.

PROJECT NAME: \_\_\_\_\_

PROJECT TYPE: \_\_\_\_\_



LCKM

PATENT PENDING

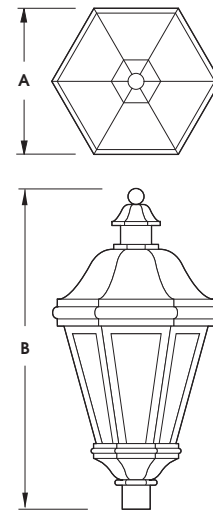

FIXTURE	A	B
LCKM1	20.5" 521mm	40" 1016mm
LCKM2	16.5" 419mm	35.5" 902mm



2013141

# LCKM SERIES - LED

## S P E C I F I C A T I O N S

### WALL MOUNT

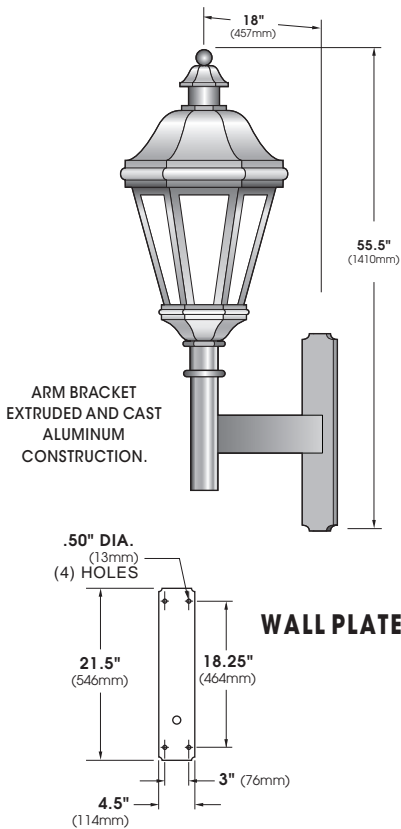

### LED POWER ARRAY™ MODULES

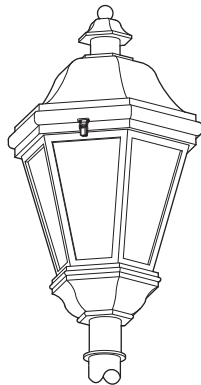

**LCKM1-LED** E.P.A. = 2.15

**ANGLED ARRAY**  
Available in:  
10 Array 80 LED Max.

**GLASS REFRACTOR w/  
VERTICAL ARRAY**  
Available in:  
6 Array 36 LED Max.

**VERTICAL ARRAY**  
Available in:  
8 Array 64 LED Max.  
10 Array 80 LED Max.

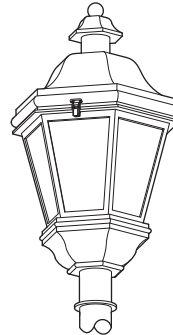

**LCKM-LED2** E.P.A. = 1.61

**ANGLED ARRAY**  
Available in:  
8 Array 48 LED Max.

**GLASS REFRACTOR w/  
VERTICAL ARRAY**  
Available in:  
6 Array 36 LED Max..

**VERTICAL ARRAY**  
Available in:  
6 Array 48 LED Max.  
8 Array 64 LED Max.

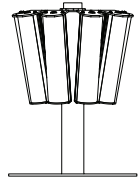

**APA - Angled Array**  
Base mount

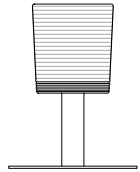

**VPA - Vertical Array**  
Base mount

(Specifications subject to change without prior notice.)

PATENT PENDING

## O R D E R I N G I N F O R M A T I O N

LUMINAIRE	OPTICS	# of LED's	COLOR	VOLTAGE	MOUNTING	FINISH	OPTIONS	
<b>LUMINAIRE</b>	<b>OPTICS</b>	<b>LED</b>			<b>MOUNTING</b>	<b>FINISH</b>	<b>OPTIONS</b>	
<input type="checkbox"/> LCKM1-LED	<b>ANGLED POWER ARRAY</b> (CLEAR PATTERNED LENS) <input type="checkbox"/> APA - II ..... <input type="checkbox"/> APA - III ..... <input type="checkbox"/> APA - IV ..... <input type="checkbox"/> APA - V .....  <b>GLASS REFRACTOR</b> (CLEAR PATTERNED OR CLEAR SMOOTH LENS) <input type="checkbox"/> GRV - III ..... <input type="checkbox"/> GRV - V .....  <b>VERTICAL POWER ARRAY</b> (OPAL LENS) <input type="checkbox"/> VPA - SYM .....	<b>No. LEDs</b> <b>LCKM1</b> <input type="checkbox"/> 80LED (89 Watts) <input type="checkbox"/> 60LED (67 Watts) <input type="checkbox"/> 40LED (45 Watts)  <small>Wattages are Max Input Watts</small>	<b>COLOR</b> <input type="checkbox"/> NW (4000K)* <small>*STANDARD</small> <input type="checkbox"/> CW (5000K) <input type="checkbox"/> WW (3000K)  <small>OTHER LED COLORS AVAILABLE CONSULT FACTORY</small>	<b>VOLTAGE</b> <input type="checkbox"/> 120 <input type="checkbox"/> 208 <input type="checkbox"/> 240 <input type="checkbox"/> 277 <input type="checkbox"/> 347 <input type="checkbox"/> 480	<b>ARM MOUNT</b> <input type="checkbox"/> 1 ..... <input type="checkbox"/> 2-180 ..... <input type="checkbox"/> 2-90 ..... <input type="checkbox"/> 3-90 ..... <input type="checkbox"/> 3-120 ..... <input type="checkbox"/> 4-90 .....  <b>WALL MOUNT</b> <input type="checkbox"/> WM .....  <b>POST TOP</b> <input type="checkbox"/> PT .....	<b>STANDARD TEXTURED FINISH</b> <input type="checkbox"/> BLACK RAL-9005-T <input type="checkbox"/> WHITE RAL-9003-T <input type="checkbox"/> GREY RAL-7004-T <input type="checkbox"/> DARK BRONZE RAL-8019-T <input type="checkbox"/> GREEN RAL-6005-T  <small>FOR SMOOTH FINISH REMOVE SUFFIX "T" (EXAMPLE: RAL-9500)</small> <small>SEE USALTG.COM FOR ADDITIONAL COLORS</small>	<b>LENS OPTIONS:</b> <input type="checkbox"/> CLEAR PATTERNED POLYCARBONATE ... CPP (STANDARD LENS) <input type="checkbox"/> CLEAR SMOOTH POLYCARBONATE ... CP <input type="checkbox"/> OPAL SMOOTH ACRYLIC ... WP <input type="checkbox"/> CLEAR PATTERNED ACRYLIC ... CPA <input type="checkbox"/> CLEAR SMOOTH ACRYLIC ... CA <input type="checkbox"/> OPAL SMOOTH POLYCARBONATE ... WA  <input type="checkbox"/> HOUSE SIDE SHIELD ... HS <input type="checkbox"/> DIMMABLE DRIVER(S) (0-10V) ... DIM <input type="checkbox"/> HIGH-LOW DIMMING FOR HARDWIRED SWITCHING OR NON-INTEGRATED MOTION SENSOR ... HLSW <input type="checkbox"/> PHOTO CELL + VOLTAGE (EXAMPLE: PC120V) ... PC+V <input type="checkbox"/> 10KV SURGE PROTECTOR ... 10SP <input type="checkbox"/> 20KV SURGE PROTECTOR (277V & 480V Only) ... 20SP	
<input type="checkbox"/> LCKM2-LED			<b>LCKM2</b> <input type="checkbox"/> 48LED (53 Watts) <input type="checkbox"/> 32LED (36 Watts)  <small>Wattages are Max Input Watts</small>					
			<b>LCKM1</b> <input type="checkbox"/> 36LED (41 Watts)  <small>Wattages are Max Input Watts</small>					
		<b>LCKM2</b> <input type="checkbox"/> 36LED (41 Watts)  <small>Wattages are Max Input Watts</small>						
		<b>LCKM1</b> <input type="checkbox"/> 80LED (89 Watts) <input type="checkbox"/> 64LED (72 Watts) <input type="checkbox"/> 48LED (53 Watts)  <small>Wattages are Max Input Watts</small>						
		<b>LCKM2</b> <input type="checkbox"/> 64LED (72 Watts) <input type="checkbox"/> 48LED (53 Watts) <input type="checkbox"/> 36LED (41 Watts)  <small>Wattages are Max Input Watts</small>						