



LUMINAIRE ACCESSORIES

(SPECIFY AS SUFFIX TO LUMINAIRE NO.)

LCWA

CAST ALUMINUM CONSTRUCTION. LUMINAIRE PROVIDED WITH ACRYLIC OR POLYCARBONATE DIFFUSER

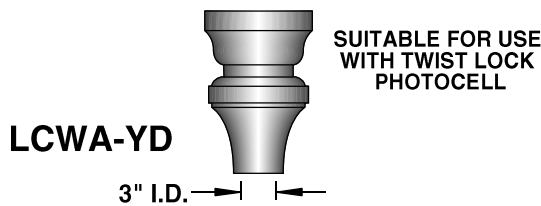
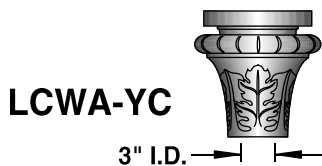
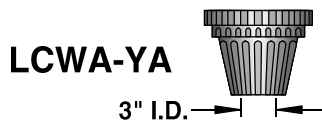
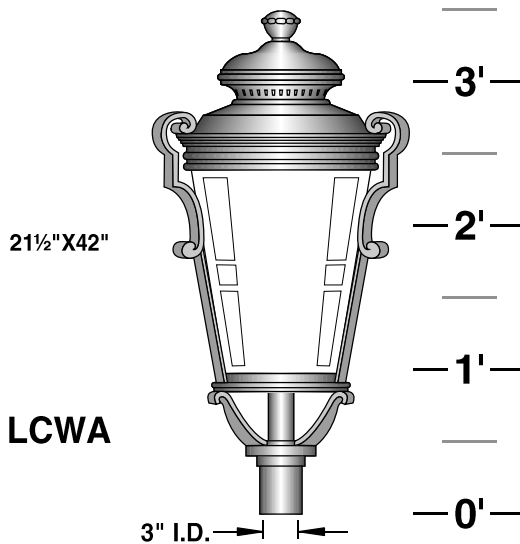

BALLASTS ARE H.P.F. / C.W.A. AUTOTRANSFORMER, -20° STARTING TEMPERATURE

METAL HALIDE	HIGH PRESSURE SODIUM	MERCURY VAPOR	FOR FLUOR. LAMPS CONSULT FACTORY
50W.	50W.	50W.	INC. TO 200W.
70W.	70W.	75W.	
100W.	100W.	100W.	
175W.	150W.	175W.	

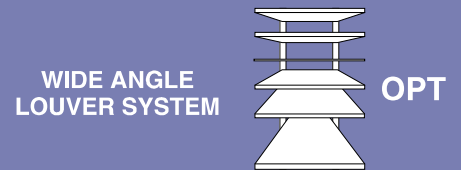
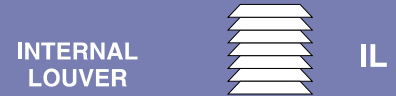

STANDARD DIFFUSER: OPAL SMOOTH ACRYLIC

OPTIONS:

- CLEAR SMOOTH ACRYLIC.....CA
- CLEAR TEXTURED ACRYLIC.....CT
- CLEAR SMOOTH POLYCARBONATE.....CP

- HOUSE SIDE SHIELD 90°.....HS90°
- 135°.....HS135°
- 180°.....HS180°

PHOTO CELL + VOLTAGE (EXAMPLE: PC120V).....PC+V

SINGLE FUSE (120V., 277V.).....SF

DOUBLE FUSE (208V., 240V., 480V.).....DF



sun valley
LIGHTING

660 WEST AVENUE O, PALMDALE, CA. 93551
(661) 233-2000
FAX NO. (661) 233-2001
www.sunvalleylighting.com

SCALE: 1/4"=1'-0"

14
13
12
11
10
9
8
7
6
5
4
3
2
1
0

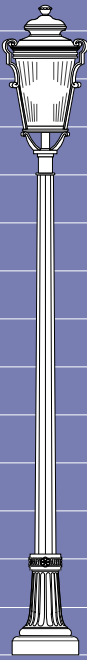

A

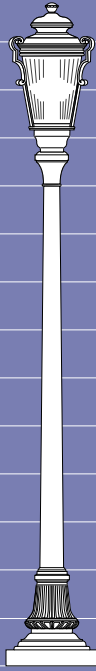

B

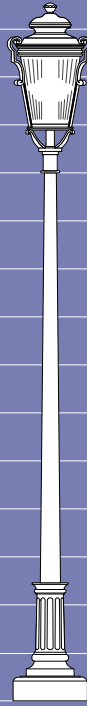

C



D

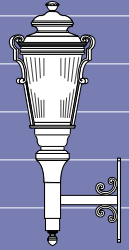

E

16
15
14
13
12
11
10
9
8
7
6
5
4
3
2
1
0

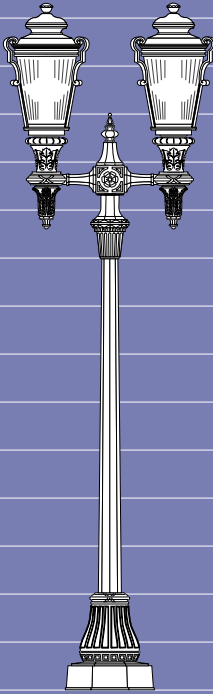

F

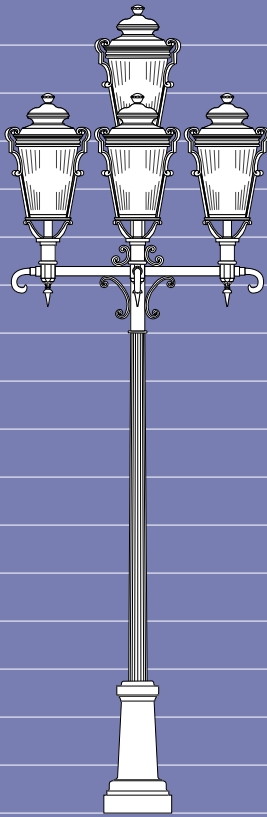

G

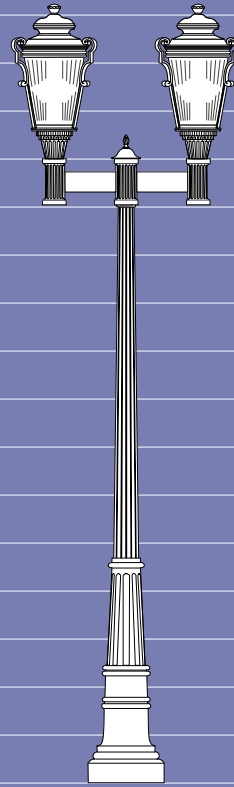

H

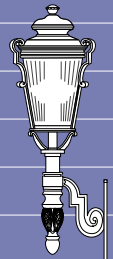

I

FT.

- A. 7-1058C-10/LCWA/PT/BALLAST/ACCESSORIES/FINISH
- B. 34-1046T-10/LCWA-YD-CT/PT/BALLAST/ACCESSORIES/FINISH
- C. 13-1035T-11/LCWA-WP/PT/BALLAST/ACCESSORIES/FINISH
- D. 10-1060-12/LCWA-CT/PT/BALLAST/ACCESSORIES/FINISH
- E. WS/LCWA-YD-CA/XAJ-WM/BALLAST/ACCESSORIES/FINISH

- F. 20-1080C-9/LCWA-YC-CT/XAP-2-180/BALLAST/ACCESSORIES/FINISH
- G. 45-1030C-10/LCWA/XAA-5-90/BALLAST/ACCESSORIES/FINISH
- H. 36-1050C-12/LCWA-YA-WP/XAM-2-180/BALLAST/ACCESSORIES/FINISH
- I. WS/LCWA-CA/XAC-WM/BALLAST/ACCESSORIES/FINISH