

# SOLID STATE AREA LIGHTING

## RAZAR-PT2 SERIES-PLED

### S P E C I F I C A T I O N S

#### OPTICAL HOUSING

Heavy cast low copper aluminum (A356 alloy; <0.2% copper) assembly with integral cooling fins. The Optical Panel mounting surface is milled flat (surface variance  $<\pm.003"$ ) to facilitate thermal transfer of heat to housing and cooling fins. Minimum wall thickness is .188". All hardware is stainless steel.

#### TWIN ARM POST TOP MOUNTING/ELECTRICAL COMPARTMENT

Two (2) 1/2" Sch.40 round aluminum arms are welded to a cast low copper aluminum (A356 alloy; <0.2% Cu) pole top tenon fitter which also serves as the LED Driver and wiring compartment. Tenon maximum 2 7/8" diameter x 3 1/2" height. All exposed hardware is stainless steel.

#### PLED™ OPTICS

Emitters (LED's) are arrayed on a metal core PCB panel with each emitter located on a copper thermal transfer pad and enclosed by an LED refractor. In asymmetric distributions, a micro-reflector inside the refractor re-directs the house side emitter output towards the street side and functions as a house side shielding element. Refractors are injection molded H12 acrylic. Each LED refractor is sealed to the PCB to meet an IP66 rating over an emitter and all refractors are retained by an aluminum frame. Any one Panel, or group of Panels in a luminaire, have the same optical pattern. Panels are field replaceable and field rotatable in 90° increments.

#### LED DRIVERS

Drivers are UL and cUL recognized mounted on a single plate and factory prewired with quick-disconnect plugs. Constant current driver is electronic and has a power factor of >0.90 and a minimum operating temperature of -40°F. In-line terminal blocks facilitate wiring between the driver and optical arrays. Drivers accept an input of 120-277V, 50/60Hz or 347V-480V, 50,60Hz. (0 - 10V dimmable driver is standard. Driver has a minimum of 3KV internal surge protection. Luminaire supplied with 20KV surge protector for field accessible installation.)

#### FINISH

Electrostatically applied TGIC Polyester Powder Coat on substrate prepared with 20 PSI power wash at 140°F. Four step sand blast and iron phosphate pretreatment for protection and paint adhesion. 400°F bake for maximum hardness and durability. Texture finish is standard.

PROJECT NAME: \_\_\_\_\_

FIXTURE TYPE: \_\_\_\_\_



RZR-PT2 PLED

PATENT PENDING

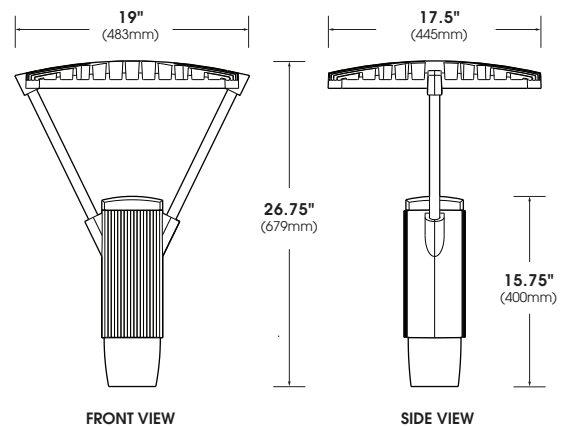

2016202

# RZR-PT2 SERIES - PLED

## S P E C I F I C A T I O N S

### PLED™ MODULES

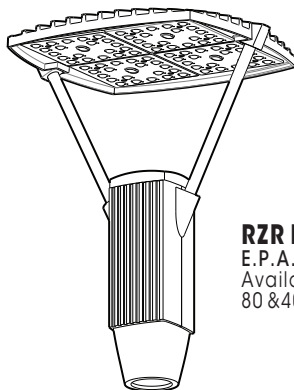

**RZR LED POST TOP2**  
E.P.A.= 1.08  
Available in:  
80 & 40 LED Array

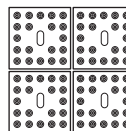

80 LED Array

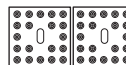











40 LED Array

No. of LEDs	Drive Current	System Watts	HID Equivalent
40	350mA	45	70 - 100
	525mA	66	100 - 150
	700mA	91	175
	1050mA	142	200 - 250
80	350mA	92	150 - 175
	525mA	136	200 - 250
	700mA	184	400

Spec/Order Example: RZR-PT2-LED/PLED-V-SQ/80LED-700mA/NW/277/RAL9005

## S P E C / O R D E R I N G I N F O R M A T I O N

MODEL	OPTICS	LED MODE			VOLTAGE	FINISH	OPTIONS
MODEL	OPTICS	NO. LEDs	DRIVE CURRENT	COLOR TEMP - CCT	VOLTAGE	FINISH	OPTIONS
<input type="checkbox"/> RZR-PT2	<input type="checkbox"/> TYPE II <b>PLED-II</b> .....  <input type="checkbox"/> TYPE II FRONT ROW <b>PLED-II-FR</b> .....  <input type="checkbox"/> TYPE II MEDIAN ILLUMINATOR <b>PLED-II-ML</b> .....  <input type="checkbox"/> TYPE III <b>PLED-III-M</b> .....  <input type="checkbox"/> TYPE III <b>PLED-III-W</b> .....  <input type="checkbox"/> TYPE IV <b>PLED-IV</b> .....  <input type="checkbox"/> TYPE IV <b>PLED-IV-FT</b> .....  <input type="checkbox"/> TYPE V NARROW <b>PLED-V-SQ-N</b> .....  <input type="checkbox"/> TYPE V <b>PLED-V-SQ-M</b> .....  <input type="checkbox"/> TYPE V <b>PLED-V-SQ-W</b> ..... 	<input type="checkbox"/> 80LED  <input type="checkbox"/> 40LED	<input type="checkbox"/> 350mA  <input type="checkbox"/> 525mA  <input type="checkbox"/> 700mA  <input type="checkbox"/> 1050mA (40LED ONLY)	<input type="checkbox"/> NW (4000K)* *STANDARD <input type="checkbox"/> CW (5000K) <input type="checkbox"/> WW (3000K) CONSULT FACTORY FOR OTHER LED COLORS	<input type="checkbox"/> 120 <input type="checkbox"/> 208 <input type="checkbox"/> 240 <input type="checkbox"/> 277 <input type="checkbox"/> 347 <input type="checkbox"/> 480	STANDARD TEXTURED FINISH <input type="checkbox"/> BLACK <b>RAL-9005-T</b>  <input type="checkbox"/> WHITE <b>RAL-9003-T</b>  <input type="checkbox"/> GREY <b>RAL-7004-T</b>  <input type="checkbox"/> DARK BRONZE <b>RAL-8019-T</b>  <input type="checkbox"/> GREEN <b>RAL-6005-T</b>  FOR SMOOTH FINISH REPLACE SUFFIX "T" WITH SUFFIX "S" (EXAMPLE: RAL-9005-S)  CONSULT FACTORY FOR CUSTOM COLORS	<input type="checkbox"/> HIGH-LOW DIMMING FOR HARDWIRED SWITCHING OR NONINTEGRATED MOTION SENSOR ..... <b>HLSW</b>  <input type="checkbox"/> INTERNAL HOUSE SIDE SHIELD ... <b>HS-PLED</b>  <input type="checkbox"/> PHOTO CELL + VOLTAGE (EXAMPLE: PC120V) ... <b>PC+V</b>  <input type="checkbox"/> TWIST LOCK PHOTO CELL + VOLTAGE (EXAMPLE: PC120V) ... <b>TPC+V</b>  <input type="checkbox"/> TWIST LOCK RECEPTACLE ONLY ... <b>TPR</b>  <input type="checkbox"/> 7-PIN TWIST LOCK RECEPTACLE ONLY ... <b>TPR7</b>  <input type="checkbox"/> SINGLE FUSE (120V, 277V, 347V) ... <b>SF</b>  <input type="checkbox"/> DOUBLE FUSE (208V, 240V, 480V) ... <b>DF</b>  <input type="checkbox"/> STEP DIM MOTION SENSOR (PROGRAMMED 50/100) ..... <b>MS-F211</b>  <input type="checkbox"/> REMOTE MOTION SENSOR CONFIGURATOR ..... <b>MS-FC10</b>

# RZR-PT2 SERIES - PLED

## LAMP/ELECTRICAL GUIDE

LED COUNT	SOURCE TYPE	SOURCE	INITIAL LUMENS - 4000K	INITIAL LUMENS - 3000K	INITIAL LUMENS - 5000K	L70 GREATER THAN (HR)	STARTING TEMP.	SYSTEM WATTS	VOLTS	MAX INPUT AMPS
40	LED	40 <b>PLED</b> Optical Module - 350mA	5,002 - 5,579	4,379 - 4,884	5,122 - 5,713	60,000+	-20°F	45	120 277	0.38 0.17
40	LED	40 <b>PLED</b> Optical Module - 525mA	7,047 - 7,860	6,170 - 6,881	7,216 - 8,049	60,000+	-20°F	66	120 277	0.55 0.24
40	LED	40 <b>PLED</b> Optical Module - 700mA	8,822 - 9,840	7,724 - 8,615	9,034 - 10,077	60,000+	-20°F	87	120 277	0.73 0.32
40	LED	40 <b>PLED</b> Optical Module - 1050mA	11,594 - 12,932	10,150 - 11,322	11,872 - 13,244	60,000+	-20°F	134	120 277	1.12 0.49
80	LED	80 <b>PLED</b> Optical Module - 350mA	10,003 - 11,158	8,758 - 9,769	10,243 - 11,426	60,000+	-20°F	87	120 277	0.75 0.33
80	LED	80 <b>PLED</b> Optical Module - 525mA	14,093 - 15,720	12,338 - 13,763	14,431 - 16,098	60,000+	-20°F	131	120 277	1.10 0.48
80	LED	80 <b>PLED</b> Optical Module - 700mA	17,644 - 19,681	15,447 - 17,230	18,067 - 20,155	60,000+	-20°F	174	120 277	1.45 0.63

### NOTES:

1. Max Input Amps is the highest of starting, operating, or open circuit currents
2. Lumen values for LED Modules vary according to the distribution type
3. System Watts includes the source watts and all driver components.
4. Fuse value should be sufficient to protect all wiring components. For electronic driver and LED component protection, use 10KV - 20KV surge suppressors.
5. L70(10K) - TM-21 6x rule applied

**WARNING:** All fixtures must be installed in accordance with local codes or the National Electrical Code. Failure to do so may result in serious personal injury.