

SVLPT222

[400 WATT MAX.]

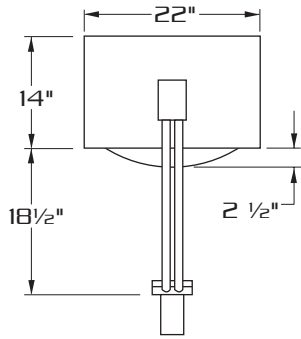

SIDE VIEW

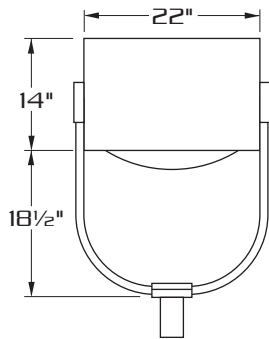

FRONT VIEW

E.P.A. = 3.30

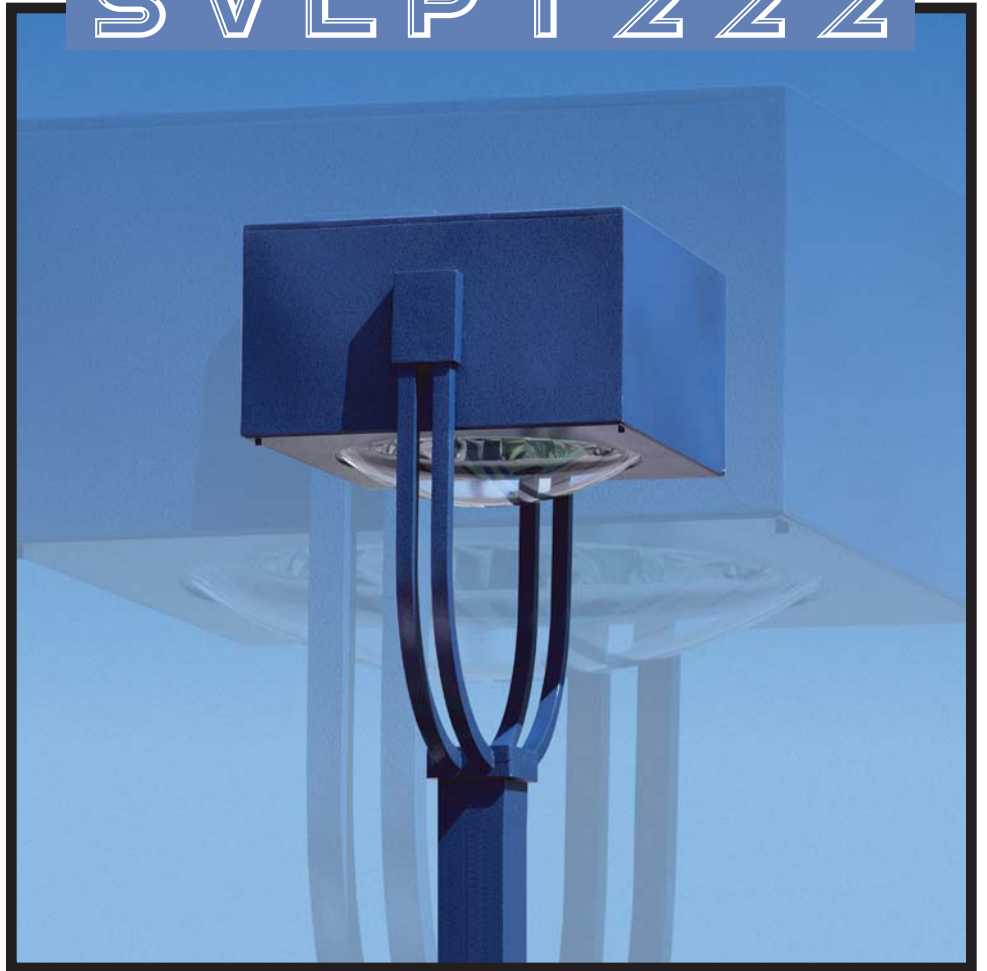

SPECIFICATIONS

- HOUSING:** ONE PIECE DIE FORMED ALUMINUM CONSTRUCTION WITH SEPARATE BALLAST COMPARTMENT.
- LENS ASS'Y:** ONE PIECE HINGED HEAVY GAUGE DIE FORMED ALUMINUM DOOR FRAME SURROUNDS 3/16" CLEAR CONVEX GLASS LENS. GLASS IS SEALED TO DOOR WITH HIGH TEMPERATURE SILICONE SEAL. TWO CAPTIVE THUMB SCREWS DISENGAGE LENS ASSEMBLY FROM HOUSING WITHOUT THE USE OF TOOLS.
- OPTICS:** COMPUTER DESIGNED ONE PIECE SEGMENTED SPECULAR REFLECTOR COMBINES WITH CLEAR CONVEX LENS TO PRODUCE A HIGHLY EFFICIENT WIDE SYMMETRIC LIGHT DISTRIBUTION WITH OUTSTANDING UNIFORMITY.
- GASKETING:** CLOSED CELL EPDM GASKETING COMPRESSED BETWEEN DOOR AND HOUSING SEALS OPTICAL CHAMBER.
- LAMP HOLDER:** M06UL BASE PORCELAIN.
- LAMP:** [BY OTHERS]
- BALLAST:** H.P.F./C.W.A. AUTOTRANSFORMER. -20° STARTING TEMPERATURE.
- ARM:** FOUR (4) ONE INCH SQUARE EXTRUDED ALUMINUM ARMS WELDED TO A CAST ALUMINUM POLE TOP FITTER. ARM ASSEMBLY IS MECHANICALLY ATTACHED TO TWIN CASTINGS WELDED TO EITHER SIDE OF THE HOUSING.
- FINISH:** POLYESTER POWDER COAT-STATE OF THE ART 20 PSI PRESSURE POWER WASH AT 140° TEMPERATURE INCORPORATES FOUR STEP IRON PHOSPHATE PROCESS TO CLEANSE AND PRETREAT THE METAL SURFACE FOR MAXIMUM PAINT ADHESION. ELECTROSTATICALLY APPLIED TEXTURED POLYESTER POWDER TOP COAT IS BAKED AT 400° TEMPERATURE FOR MAXIMUM HARDNESS AND EXTERIOR DURABILITY.



MOUNTING STYLES

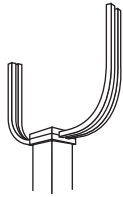

PTA

STANDARD TENON ASSEMBLY FOR 4" & 5" SQUARE POLES.

DECORATIVE RING SUPPLIED FOR 6" SQUARE POLES. (SPECIFY POLE I.D.)

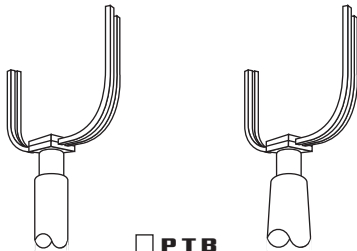

PTB

TENON ASSEMBLY FOR TAPERED OR ROUND POLES. TENON ASSEMBLY IS ALSO AVAILABLE AS AN OPTION FOR 4", 5" OR 6" SQUARE POLES.

SPECIFY MOUNTING ASSEMBLY:

PTB27-TO FIT OVER 2 7/8" O.D. TENON.

PTB23-TO FIT OVER 2 3/8" O.D. TENON.

WALL MOUNT

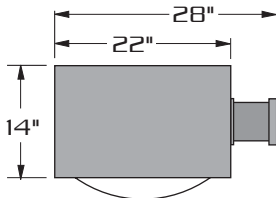
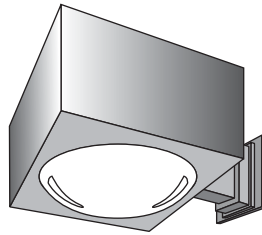

EXTRUDED ALUMINUM ARM AND CAST ALUMINUM WALL BRACKET ASSEMBLY PROVIDED WITH BUILT IN GASKETED WIRE ACCESS FOR FIXTURE/SUPPLY WIRE CONNECTION.

WALL PLATE

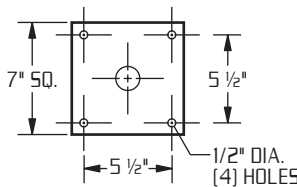

**LAMP SIZE:
250 - 400 WATT**

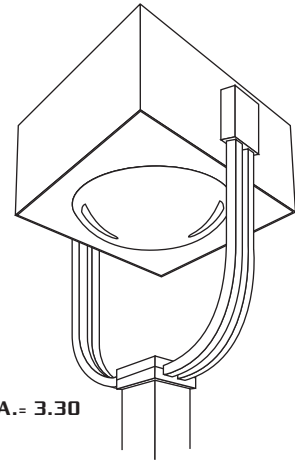

E.P.A.= 3.30

WIDE THROW BEAM PATTERN.

VERTICAL LAMP.

COMPUTER DESIGNED SEGMENTED OPTICS.

THREE OPTICAL CONFIGURATIONS.

FLAT GLASS OPTION FOR FULL CUTOFF OPTICS.

ORDERING INFORMATION

MODEL NO.:	OPTICS	WATTAGE TYPE VOLTAGE	MOUNTING	FINISH	OPTIONS	
SVLPT222						
MODEL NO.:	OPTICS	LAMP	MOUNTING	FINISH	OPTIONS	
S V L P T 2 2 2	<input type="checkbox"/> ASYMMETRIC ASY...	<input type="checkbox"/> 1000 MH (BT37) <input type="checkbox"/> 120	<input type="checkbox"/> PTA <input type="checkbox"/> PTB23 (TO FIT 2 3/8" O.D.) <input type="checkbox"/> PTB27 (TO FIT 2 7/8" O.D.) <input type="checkbox"/> WALL MOUNT <input type="checkbox"/> WM	STANDARD TEXTURED FINISH	<input type="checkbox"/> FLAT TEMPERED GLASS..... FG	
	<input type="checkbox"/> TYPE IV (FORWARD THROW) IV.....	<input type="checkbox"/> 1000 PSMH (BT37) <input type="checkbox"/> 208		<input type="checkbox"/> BLACK RAL-9005-T	<input type="checkbox"/> CLEAR POLYCARBONATE DIFFUSER..... LEX	
	<input type="checkbox"/> TYPE V V-SQ...	<input type="checkbox"/> 750 PSMH (BT37) <input type="checkbox"/> 240		<input type="checkbox"/> WHITE RAL-9003-T	<input type="checkbox"/> HOUSE SIDE SHIELD..... HS	
		<input type="checkbox"/> 450 PSMH (ED37) <input type="checkbox"/> 277		<input type="checkbox"/> GREY RAL-7004-T	<input type="checkbox"/> PHOTO CELL + VOLTAGE (EXAMPLE: PC120V)..... PC+V	
		<input type="checkbox"/> 400 MH (ED37) <input type="checkbox"/> MT		<input type="checkbox"/> DRK BRONZE RAL-8019-T	<input type="checkbox"/> TWIST LOCK PHOTO CELL+VOLTAGE (EXAMPLE TPC120V)..... TPC+V	
		<input type="checkbox"/> 400 PSMH (ED37)		<input type="checkbox"/> GREEN RAL-6005-T	<input type="checkbox"/> TWIST LOCK RECEPTACLE ONLY..... TPR	
		<input type="checkbox"/> 750 HPS (BT37)			<input type="checkbox"/> SINGLE FUSE (120V., 277V)..... SF	
		<input type="checkbox"/> 400 HPS (ED18)			<input type="checkbox"/> DOUBLE FUSE (208V., 240V)..... DF	
					FOR SMOOTH FINISH REMOVE SUFFIX "T" (EXAMPLE: RAL-9500)	
					SEE WEBSITE FOR ADDITIONAL COLORS	