

SOLID STATE AREA LIGHTING

TRILUX™ WALLMOUNT SERIES-LED

S P E C I F I C A T I O N S

HOUSING & BRACKET ARM ASSEMBLY
Precision cast aluminum construction.

LUMINAIRE
Heavy wall, precisely machined aluminum construction.

GASKETING
Silicone o-ring provided between housing and lens to prevent contaminants and moisture.

LENS
Clear Borosilicate tempered glass lens is standard. (Frosted lens is optional)

LED EMITTERS
Luxeon-S emitters available in 80CRI 2700K, 3000K, 3500K, and 4000K(standard) color temps. 90 CRI in 3000K only. Emitters are mechanically fastened to rear heat sink and are field replaceable. Emitters are driven @350mA for a nominal wattage of 9 Watts per LED.

LED DRIVER
Constant Current LED Driver is sealed in housing base. Driver accepts input voltages from 100-277Vac. Drivers are IP66 rated. 0-10V dimming optional.

OPTICS
Mold injected, aluminum coated polycarbonate Reflectors provided with a clear protective lacquer available in 12, 28, 45, and 56 degree beam spreads. Optics click into LED base for precise alignment.

MOUNTING
2.5" O.D. and 4.5" O.D. units to mount to 3" junction box. (By others) 5.5" O.D. units to mount to 4" junction box.(By others)

FINISH
Polyester powder coat incorporates four step iron phosphate process to cleanse and treat the metal surface for maximum paint adhesion. Electrostatically applied textured polyester powder topcoat is baked at 400°F for maximum hardness and exterior durability.





PROJECT NAME: _____

PROJECT TYPE: _____



TLW
LED technology has been added to Trilux™. These handsome, quality wall luminaires have been optically designed and engineered for maximum light output and maximum light distribution. Three styles and three sizes listed below.

	Diameter -	2.5"	4.5"	5.5"
 Flush Lens	Model -	TLW-LF-209	TLW-LF-427	TLW-LF-536
	Max Watt -	9W	27W	36W
 Recess Lens	Model -	TLW-LR-209	TLW-LR-427	TLW-LR-536
	Max Watt -	9W	27W	36W
 Angled Lens	Model -	TLW-LA-209	TLW-LA-427	TLW-LA-536
	Max Watt -	9W	27W	36W

2014303

TRILUX™ WALLMOUNT SERIES-LED

S P E C I F I C A T I O N S

TLW-LF
FLUSH LENS

TLW-LR
RECESS LENS

TLW-LA
ANGLED LENS

HOUSING AND BRACKET

9W
2.5" O.D.



TLW-LF-209



TLW-LR-209

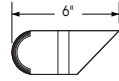

TLW-LA-209

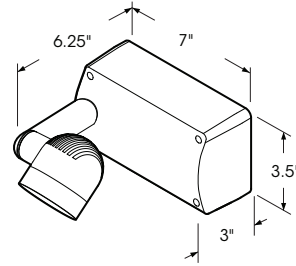

4000K Neutral White, 80 CRI LED's are standard.

Luxeon-S LED's provide high lumen output and high color rendering. LED's are mechanically attached to a patented heatsink.

Constant current LED driver accepts input voltages ranging from 100VAC to 277VAC.

Electronics are enclosed in a watertight housing.

Driver and LED's are factory pre-wired.

27W
4.5" O.D.

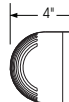

TLW-LF-427

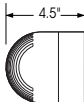

TLW-LR-427

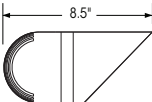

TLW-LA-427

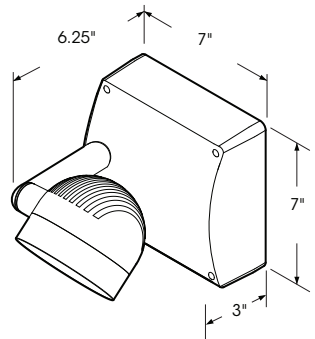

36W
5.5" O.D.



TLW-LF-536



TLW-LR-536

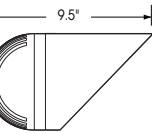

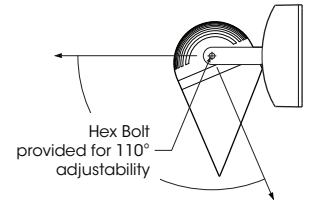

TLW-LA-536



Spec/Order Example: TLW-LR-427/3LED-3500K/45/RAL-9003-S/CG

S P E C / O R D E R I N G I N F O R M A T I O N

MODEL / LENS	NO. LEDS	COLOR	BEAM ANGLE	FINISH	OPTIONS
MODEL/LENS	LED MODE		OPTICS	FINISH	OPTIONS
	NO. LEDS	COLOR	BEAM ANGLE	STANDARD TEXTURED FINISH	
<input type="checkbox"/> TLW-LF-209 Flush <input type="checkbox"/> TLW-LR-209 Recessed <input type="checkbox"/> TLW-LA-209 Angled	<input type="checkbox"/> 1LED (10 Watts)	<input type="checkbox"/> 2700K 80CRI <input type="checkbox"/> 3000K80 80CRI <input type="checkbox"/> 3000K90 90CRI	<input type="checkbox"/> 12° SPOT <input type="checkbox"/> 28° MEDIUM  <input type="checkbox"/> 45° WIDE  <input type="checkbox"/> 56° X-WIDE 	<input type="checkbox"/> BLACK RAL-9005-T <input type="checkbox"/> WHITE RAL-9003-T <input type="checkbox"/> GREY RAL-7004-T <input type="checkbox"/> DARK BRONZE RAL-8019-T <input type="checkbox"/> GREEN RAL-6005-T	<input type="checkbox"/> CLEAR GLASS (STANDARD) CG <input type="checkbox"/> FROSTED GLASS . . FRG <input type="checkbox"/> SINGLE FUSE (120V. , 277V) . . . SF <input type="checkbox"/> DOUBLE FUSE (208V. , 240V) . . . DF <input type="checkbox"/> DIMMABLE DRIVER(S) DIM
<input type="checkbox"/> TLW-LF-427 Flush <input type="checkbox"/> TLW-LR-427 Recessed <input type="checkbox"/> TLW-LA-427 Angled	<input type="checkbox"/> 3LED (30 Watts)	<input type="checkbox"/> 3500K 80CRI <input type="checkbox"/> *4000K 80CRI *(Standard)		FOR SMOOTH FINISH REPLACE SUFFIX "T" WITH SUFFIX "S" (EXAMPLE: RAL-9005-S)	CHECK WITH FACTORY FOR AVAILABILITY OF DIMMABLE DRIVERS FOR LOWER WATTAGES
<input type="checkbox"/> TLW-LF-536 Flush <input type="checkbox"/> TLW-LR-536 Recessed <input type="checkbox"/> TLW-LA-536 Angled	<input type="checkbox"/> 4LED (40 Watts)	CONSULT FACTORY FOR OTHER LED COLORS		CONSULT FACTORY FOR CUSTOM COLORS	