

SOLID STATE AREA LIGHTING

VRS SERIES-LED PT

S P E C I F I C A T I O N S

HOUSING

Unitized 0.125" heavy wall aluminum construction. Upper side vents are protected with perforated aluminum panels. Side vents and bottom lens frame vents provide passive and forced convective cooling of the VLED® module. Internal driver compartment is gasketed and sealed.

VLED® OPTICS

Low copper A356 alloy (<.2% copper) cast aluminum housing. Integrated clear tempered 3/16" glass lens sealed with a continuous silicone gasket protects emitters (LED's) and emitter Reflector-Prism optics, and seals the module from water intrusion and environmental contaminants. Entire module meets an IP67 rating. Emitters (LED's) are Luxeon Rebel ES, high output, Neutral White nominal 4100K CCT for the entire module (Cool White nominal 5300K are available). Each emitter is optically controlled by a Reflector-Prism injection molded from H12 acrylic (3 types per module; one from 0° - 50°; one from 50° - 65°; one from 65° - 72°). Each Reflector-Prism has indexing pins for aiming and is secured to an optical plate made of matte black anodized aluminum. The optical plate locates every Reflector-Prism over an emitter. Reflector-Prisms are secured to the optical plate with a UV curing adhesive. The Reflector-Prisms are arrayed to produce IES Type II, III, IV, and V-SQ light distributions. The entire Optical Module is field rotatable in 90° increments. Both module and drivers are factory wired using water resistant, insulated cord. Lens, module and drivers are field replaceable.

LED DRIVERS

Drivers are UL and cUL recognized mounted on a single plate and factory prewired with quick-disconnect plugs. Constant current driver is electronic and has a power factor of >0.90 and a minimum operating temperature of -40°F. Drivers accept an input of 120-277V, 50/60Hz. (Consult factory for dimming applications)

MOUNTINGS

Post Top - Four (4) 1" Square extruded aluminum arms welded to a cast aluminum pole top fitter. Arm assembly is mechanically attached to twin castings welded to either side of the housing.

Wall - Heavy wall extruded aluminum arm with draw bolts integrates with a cast aluminum wall plate and mounting bracket.

Canopy - Standard 1" high cast aluminum mounting plate with central wireway or 2" high heavy gauge wire box with 3/4" conduit knockouts on each side.

FINISH

Electrostatically applied TGIC Polyester Powder Coat on substrate prepared with 20 PSI power wash at 140°F. Four step sand blast and iron phosphate pretreatment for protection and paint adhesion. 400°F bake for maximum hardness and durability. Texture finish is standard.

PROJECT NAME: _____

FIXTURE TYPE: _____



VRS LED PT

PATENT PENDING

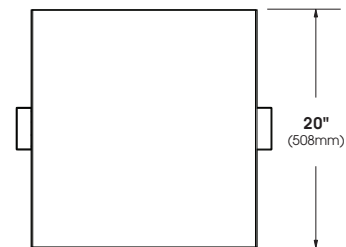

TOP VIEW

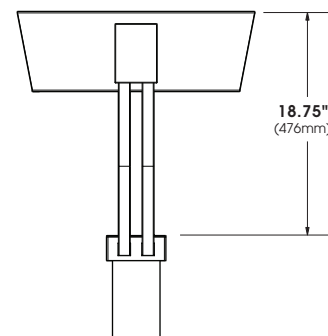

SIDE VIEW



2015084

VRS SERIES - LED PT

S P E C I F I C A T I O N S

CANOPY MOUNT

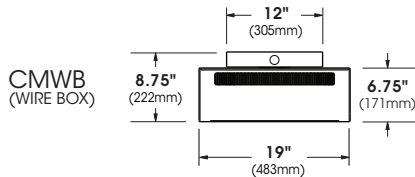
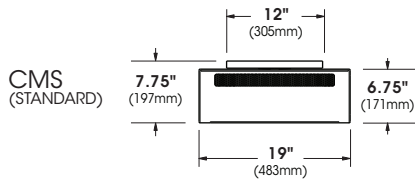

WALL MOUNT

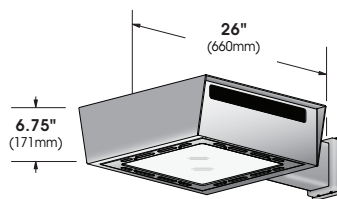

WALL PLATE

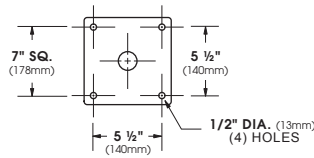

VLED® MODULES

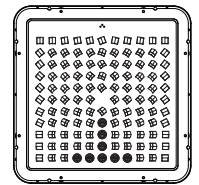
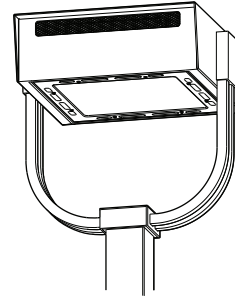

120 LED Module

VRS LED POST TOP

E.P.A. = 1.66

Available in:

120, 80, 64 & 48 LED Module

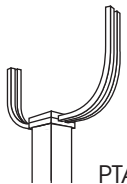

PTA

STANDARD TENON ASSEMBLY FOR 4" & 5" DIA. POLES.

DECORATIVE RING SUPPLIED FOR 6" DIA. POLES. (SPECIFY POLE I.D.)

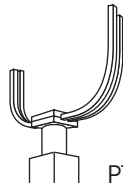

PTB

TENON ASSEMBLY FOR TAPERED OR SQ. POLES. TENON ASSEMBLY IS ALSO AVAILABLE AS AN OPTION FOR 4", 5" OR 6" DIA. POLES

SPECIFY MOUNTING ASSEMBLY:
PTB27-TO FIT OVER 2 7/8" O.D. TENON.
PTB23-TO FIT OVER 2 3/8" O.D. TENON.

MAX INPUT WATTAGE

# OF LED'S	DRIVE CURRENT 350mA	525mA	700mA
120	130W	192W	-
80	85W	130W	167W
64	70W	108W	134W
48	55W	79W	109W

Spec/Order Example: VRS LED PT/VLED-V-SQ/120LED 350mA-CW 277/PT/RAL7004

S P E C / O R D E R I N G I N F O R M A T I O N

MODEL	OPTICS	LED			MOUNTING	FINISH	OPTIONS
<input type="checkbox"/> VRS LED PT	<input checked="" type="checkbox"/> VLED® <input type="checkbox"/> TYPE II VLED-II <input type="checkbox"/> TYPE III VLED-III <input type="checkbox"/> TYPE IV VLED-IV <input type="checkbox"/> TYPE V VLED-V-SQ	No. LEDs <input type="checkbox"/> 120LED ¹ <input type="checkbox"/> 100LED ¹ <input type="checkbox"/> 80LED <input type="checkbox"/> 64LED <input type="checkbox"/> 48LED	DRIVE CURRENT <input type="checkbox"/> 700mA <input type="checkbox"/> 525mA <input type="checkbox"/> 350mA	COLOR TEMP-CCT <input type="checkbox"/> NW (4000K)* *STANDARD <input type="checkbox"/> CW (5000K) <input type="checkbox"/> WW (3000K) OTHER LED COLORS AVAILABLE CONSULT FACTORY	YOLK MOUNT <input type="checkbox"/> PTA <input type="checkbox"/> PTB WALL MOUNT <input type="checkbox"/> WM CANOPY MOUNT <input type="checkbox"/> CMS (STANDARD) <input type="checkbox"/> CMWB (WIRE BOX)	STANDARD TEXTURED FINISH <input type="checkbox"/> BLACK RAL-9005-T <input type="checkbox"/> WHITE RAL-9003-T <input type="checkbox"/> GREY RAL-7004-T <input type="checkbox"/> DARK BRONZE RAL-8019-T <input type="checkbox"/> GREEN RAL-6005-T FOR SMOOTH FINISH REPLACE SUFFIX "T" WITH SUFFIX "S" (EXAMPLE: RAL-9005-S) SEE USALTG.COM FOR ADDITIONAL COLORS	<input type="checkbox"/> HIGH-LOW DIMMING FOR HARDWIRED SWITCHING OR NONINTEGRATED MOTION SENSOR HLSW <input type="checkbox"/> INTERNAL HOUSE SIDE SHIELD HS <input type="checkbox"/> EXTERNAL HOUSE SIDE SHIELD EHS <input type="checkbox"/> PHOTO CELL + VOLTAGE (EXAMPLE: PC120V) PC+V <input type="checkbox"/> TWIST LOCK PHOTO CELL + VOLTAGE (EXAMPLE: PC120V) TPC+V <input type="checkbox"/> TWIST LOCK RECEPTACLE ONLY TPR <input type="checkbox"/> SINGLE FUSE (120V, 277V) SF <input type="checkbox"/> DOUBLE FUSE (208V, 240V, 480V) DF
		NOTE: 1 - AVAILABLE IN ARM AND POST TOP MODELS ONLY. NOT AVAILABLE IN 700mA.					
		VOLTAGE <input type="checkbox"/> 120 <input type="checkbox"/> 208 <input type="checkbox"/> 240 <input type="checkbox"/> 277 <input type="checkbox"/> 340 <input type="checkbox"/> 480					

VRS SERIES - LED PT

LAMP/ELECTRICAL GUIDE

LED COUNT	SOURCE TYPE	SOURCE	INITIAL LUMENS - 4000K	INITIAL LUMENS - 3000K	INITIAL LUMENS - 5000K	L70 GREATER THAN (HR)	STARTING TEMP.	SYSTEM WATTS	VOLTS	MAX INPUT AMPS
48	LED	48 ✓LED® Optical Module - 350mA	4,241 - 4,760	3,731 - 4,187	4,337 - 4,868	60,000+	-20°F	55	120 277 347	0.46 0.20 0.16
48	LED	48 ✓LED® Optical Module - 525mA	5,871 - 6,557	5,152 - 5,755	6,009 - 6,711	60,000+	-20°F	79	120 277 347	0.66 0.29 0.23
48	LED	48 ✓LED® Optical Module - 700mA	7,515 - 8,131	6,579 - 7,119	7,696 - 8,327	60,000+	-20°F	109	120 277 347	0.91 0.40 0.32
64	LED	64 ✓LED® Optical Module - 350mA	5,255 - 5,898	4,623 - 5,189	5,373 - 6,031	60,000+	-20°F	70	120 277 347	0.59 0.26 0.21
64	LED	64 ✓LED® Optical Module - 525mA	7,393 - 8,257	6,488 - 7,246	7,566 - 8,451	60,000+	-20°F	108	120 277 347	0.90 0.39 0.32
64	LED	64 ✓LED® Optical Module - 700mA	9,927 - 10,405	8,691 - 9,110	10,166 - 10,655	60,000+	-20°F	134	120 277 347	1.12 0.49 0.39
80	LED	80 ✓LED® Optical Module - 350mA	7,131 - 7,452	6,273 - 6,556	7,292 - 7,620	60,000+	-20°F	85	120 277 347	0.77 0.31 0.25
80	LED	80 ✓LED® Optical Module - 525mA	9,994 - 10,444	8,770 - 9,166	10,228 - 10,689	60,000+	-20°F	130	120 277 347	1.09 0.47 0.38
80	LED	80 ✓LED® Optical Module - 700mA	12,408 - 13,005	10,863 - 11,386	12,707 - 13,318	60,000+	-20°F	167	120 277 347	1.40 0.61 0.49
100	LED	120 ✓LED® Optical Module - 350mA	8,862 - 9,620	7,796 - 8,146	9,062 - 9,469	60,000+	-20°F	109	120 277 347	0.91 0.40 0.32
100	LED	120 ✓LED® Optical Module - 525mA	12,261 - 12,813	10,786 - 11,271	12,537 - 13,102	60,000+	-20°F	160	120 277 347	1.34 0.58 0.47
120	LED	120 ✓LED® Optical Module - 350mA	10,634 - 11,112	9,355 - 9,776	10,874 - 11,363	60,000+	-20°F	130	120 277 347	1.09 0.47 0.38
120	LED	120 ✓LED® Optical Module - 525mA	14,713 - 15,375	12,911 - 13,809	15,057 - 16,104	60,000+	-20°F	192	120 277 347	1.60 0.70 0.56

NOTES:

1. Max Input Amps is the highest of starting, operating, or open circuit currents
2. Lumen values for LED Modules vary according to the distribution type
3. System Watts includes the source watts and all driver components.
4. Fuse value should be sufficient to protect all wiring components. For electronic driver and LED component protection, use 10KV - 20KV surge suppressors.
5. L70(9K) - TM-21 6x rule applied

WARNING: All fixtures must be installed in accordance with local codes or the National Electrical Code. Failure to do so may result in serious personal injury.