

# AREA & ROADWAY LIGHTING

## L AFC SERIES - LED

### SPECIFICATIONS

#### Luminaire

One piece high impact clear acrylic patterned diffusing globe provided with durable corrosion resistant cast aluminum fitter and cage. Standard fitter has 3" I.D. opening for 2.88" OD tenon. All hardware is stainless steel. Luminaire is UL® Listed for Wet Location.

#### LED POWER ARRAY™ 2

Three-dimensional array of individual LED Tubes fastened to retaining plates. Each LED Tube consists of circuit board populated with a multiple of LED's covered with a gasketed acrylic lens and mechanically fastened to an extruded aluminum heatsink. Tubes are sealed to an IP65 Standard.

**Area and Roadway Distributions:** Acrylic Tube Lenses have individual molded-in refractive optics for each LED and provides concisely tailored beam patterns. LED Tubes are uniquely aimed horizontally and beam patterns combine to produce wide throw, highly efficient IES Distribution Types II, III, IV and V with minimal uplight. Used in conjunction with a clear patterned diffusing globe only.

**General Diffused Lighting:** Acrylic Tube Lense provides duffusion of the raw LED distributions. Tubes are combined to produce uniform luminance of the outer globe. Used in conjunction with an opal patterned diffusing globe only.

#### LED Emitters

High Power White LED's are driven between 350mA and 700mA for a maximum output of 2 Watts nominal. LED's are available in standard Neutral White (4000K), Cool White (5000K), or Warm White (2700K & 3000K). All Standard LED's have a minimum of 70 CRI. Consult Factory for other LED options. Lumen Maintenance of L94 at 60,000 hours (TM-21 calculated at 6x Test Time).

#### LED Driver

Constant current electronic with a power factor of >0.90 and a minimum operating temperature of -40°F/-40°C. Driver(s) is/are UL and cUL recognized. Drivers accept an input of 120-277V, 50/60Hz or 347V-480V, 50/60Hz. 0-10V dimmable driver is standard. Driver has a minimum of 3KV internal surge protection. Luminaire supplied with 20KV surge protector for field installation.

**True Amber LED's** TRA-True Amber LED's emit light in the amber spectral bandwidth centered on 585-590nm. True Amber has negligible blue light and is suitable for wildlife.

#### Finish

Polyester powder coat incorporates four step iron phosphate process to pretreat metal surface for maximum adhesion. Top coat is baked at 400°F for maximum hardness and exterior durability.

PROJECT NAME: \_\_\_\_\_

PROJECT TYPE: \_\_\_\_\_



## L AFC

SHOWN WITH STANDARD -YA FITTER

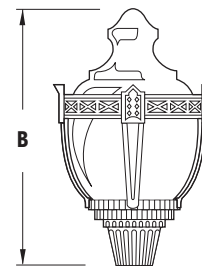
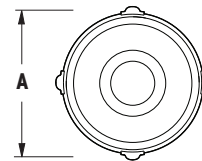

FIXTURE	A	B
L AFC1*	18.5" 470mm	32.0" 813mm
L AFC2*	17" 432mm	27.5" 699mm

\*Height Varies With Fitter. See Page 3.



2021312

# LAFC SERIES - LED

## SPECIFICATIONS

### FITTER OPTIONS

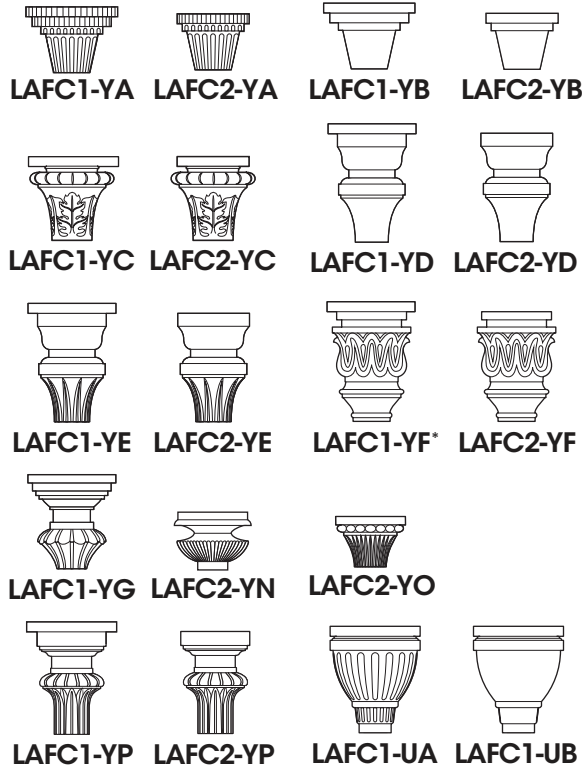

All Fitters Available with Mini-Button Photocells.  
YD, YE, UA, & UB Available with Twist-Lock Photocells.

### EPA & WEIGHT



**LAFC1**  
Max Weight = 41 lbs  
Max EPA = 2.13  
80 LED Max



**LAFC2**  
Max Weight = 38 lbs  
Max EPA = 1.65  
64 LED Max

### POWER ARRAY™ 2 MODULES

#### POWER ARRAY™ 2 10 Tube Array

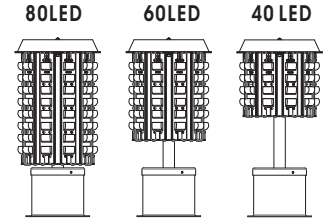

#### POWER ARRAY™ 2 8 Tube Array

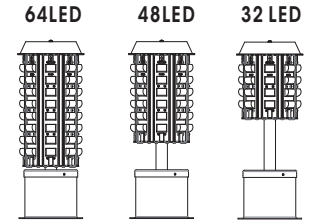

## ORDERING INFORMATION

Spec/Order Example: LAFC1-YP/PA2-IV/60LED/525mA/30K/347/PT/RAL-7005-S/CPA/OF

LUMINAIRE-FITTER	OPTICS	# of LED's	DRIVE CURRENT	CCT	VOLTAGE	MOUNTING	FINISH	OPTIONS
Luminaire	Optics	LED			Voltage	Mounting	Finish	Options
<b>LAFC1</b> <input type="checkbox"/> LAFC1-YA <input type="checkbox"/> LAFC1-YB <input type="checkbox"/> LAFC1-YC <input type="checkbox"/> LAFC1-YD <input type="checkbox"/> LAFC1-YE <input type="checkbox"/> LAFC1-YF <input type="checkbox"/> LAFC1-YG <input type="checkbox"/> LAFC1-YP <input type="checkbox"/> LAFC1-UA <input type="checkbox"/> LAFC1-UB  <b>LAFC2</b> <input type="checkbox"/> LAFC2-YA <input type="checkbox"/> LAFC2-YB <input type="checkbox"/> LAFC2-YC <input type="checkbox"/> LAFC2-YD <input type="checkbox"/> LAFC2-YE <input type="checkbox"/> LAFC2-YF <input type="checkbox"/> LAFC2-YN <input type="checkbox"/> LAFC2-YO <input type="checkbox"/> LAFC2-YP	<b>Area &amp; Roadway</b> (CLEAR PATTERNED LENS) <input type="checkbox"/> PA2 - II <input type="checkbox"/> PA2 - III <input type="checkbox"/> PA2 - IV <input type="checkbox"/> PA2 - V  <b>General Diffuse</b> (OPAL PATTERNED LENS) <input type="checkbox"/> PA2- SYM	<b># of LED's</b> <b>LAFC1</b> <input type="checkbox"/> 80LED <input type="checkbox"/> 60LED <input type="checkbox"/> 40LED  <b>LAFC2</b> <input type="checkbox"/> 64LED <input type="checkbox"/> 48LED <input type="checkbox"/> 32LED  *TRA Available only in 350mA and 525mA Drive Currents Consult Factory for Other Drive Currents	<b>Drive Current</b> <input type="checkbox"/> 350mA <input type="checkbox"/> 525mA <input type="checkbox"/> 700mA	<b>Color Temp-CCT</b> <input type="checkbox"/> 27K (2700K) <input type="checkbox"/> 30K (3000K) <input type="checkbox"/> 40K (4000K) <input type="checkbox"/> 50K (5000K)  <input type="checkbox"/> TRA True Amber* Consult Factory for Other LED Color, CCT, & CRI Options	<input type="checkbox"/> 120 <input type="checkbox"/> 208 <input type="checkbox"/> 240 <input type="checkbox"/> 277 <input type="checkbox"/> 347 <input type="checkbox"/> 480	<b>Arm Mount</b> <input type="checkbox"/> 1 <input type="checkbox"/> 2-180 <input type="checkbox"/> 2-90 <input type="checkbox"/> 3-90 <input type="checkbox"/> 3-120 <input type="checkbox"/> 4-90  <b>Wall Mount</b> <input type="checkbox"/> WM  <b>Post Top</b> <input type="checkbox"/> PT	<b>Standard Textured Finish</b> <input type="checkbox"/> Black RAL-9005-T <input type="checkbox"/> White RAL-9003-T <input type="checkbox"/> Grey RAL-7004-T <input type="checkbox"/> Dark Bronze RAL-8019-T <input type="checkbox"/> Green RAL-6005-T  For Smooth Finish, Replace Suffix "T" With Suffix "S" Example: RAL-9500-S Consult Factory for Custom Colors	<b>Lens Options:</b> <input type="checkbox"/> Clear Patterned Acrylic (STANDARD GLOBE) CPA <input type="checkbox"/> Opal Patterned Acrylic WA  <input type="checkbox"/> Brass Finial BF <input type="checkbox"/> Ornamental Finial OF <input type="checkbox"/> House Side Shield HS  <input type="checkbox"/> High-Low Dimming for Switch (BY OTHERS) Select 25/100 Or 50/100 (EX HLSW25) HLSW** <input type="checkbox"/> Pole Mounted Bluetooth Photo/Motion Sensor. (Factory 50/100 Motion Photo 75 fc) MS-F311 <input type="checkbox"/> Mini-Button Photocell + Voltage PC+V <input type="checkbox"/> Std. Twist Lock Photocell Receptacle TPR <input type="checkbox"/> 7 Pin Twist Lock Photocell Receptacle TPR7 <input type="checkbox"/> SINGLE FUSE SF <input type="checkbox"/> DOUBLE FUSE DF

# LAFC SERIES - LED

## GLOBE AND FITTER CONFIGURATIONS

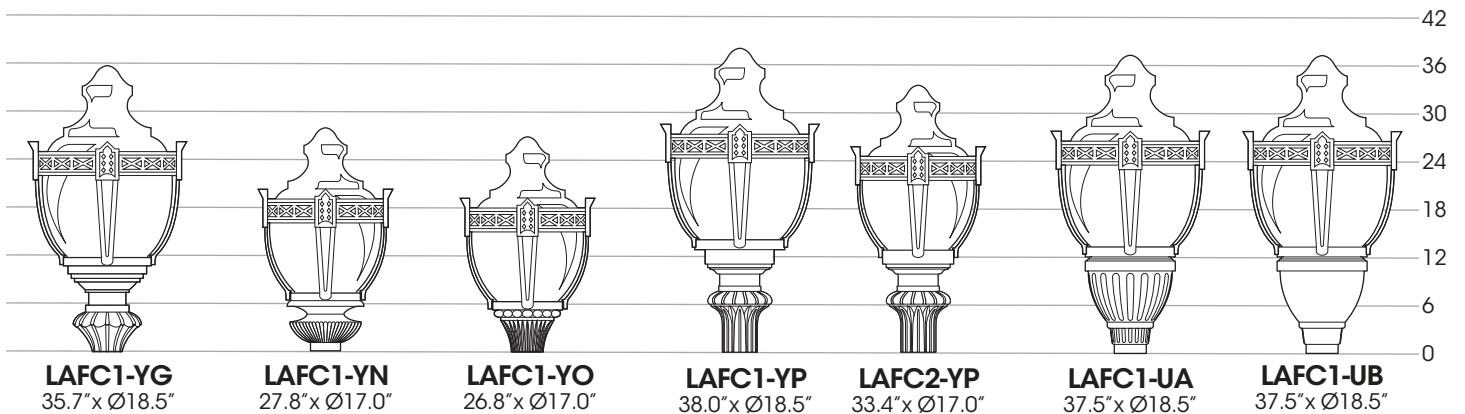
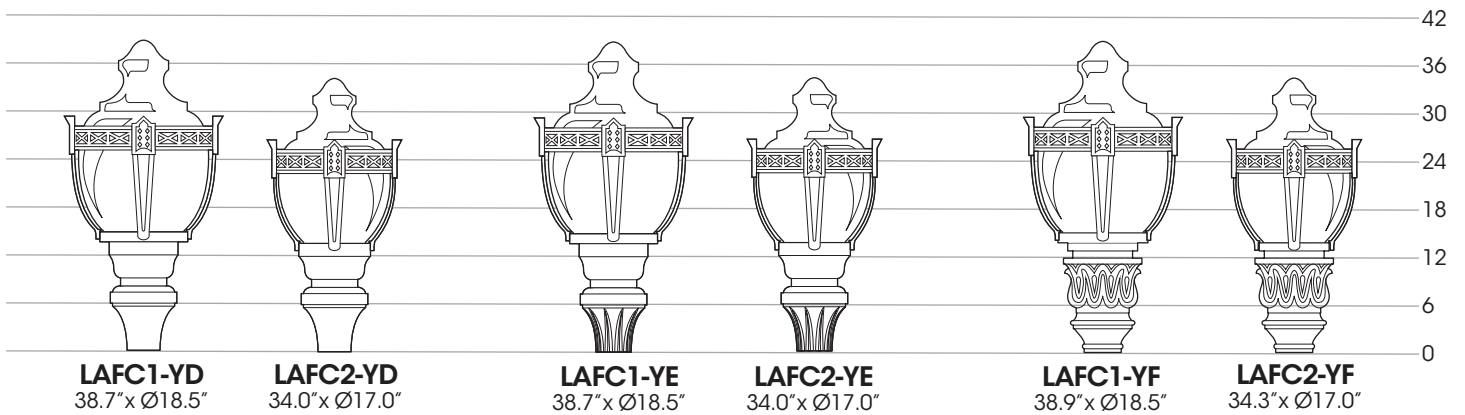
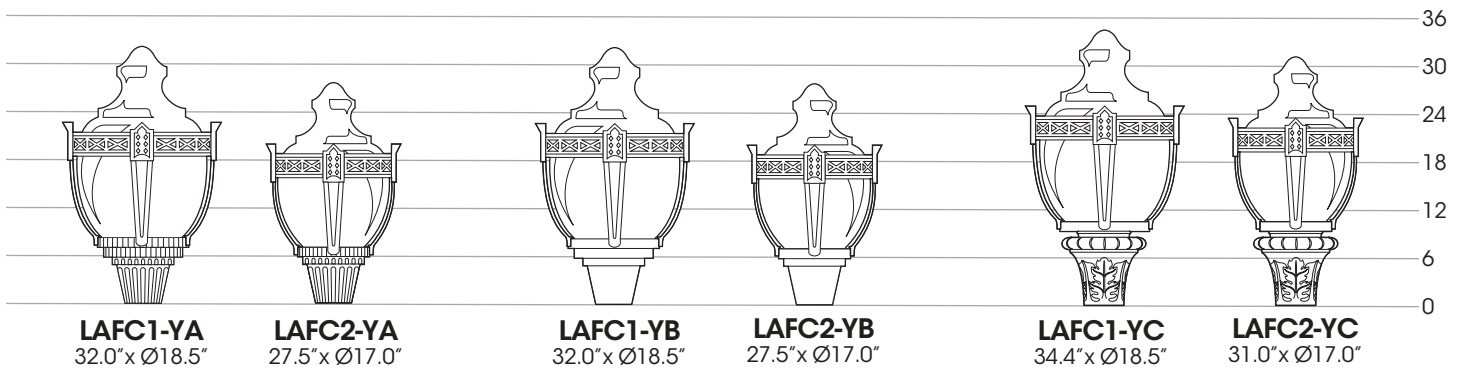

### Notes:

All Fitters Have 3" ID Opening for 2.88" OD Tenon.  
Standard Tenon Length is 3.0".  
Stainless Steel Set Screws Provided for Mounting.  
All Fitters Can Accept Mini-Button Photo Cells.  
YD, YE, UA, & UB Fitters Can Accept Standard  
Twist Lock Photo Cells (See Detail).  
UA & UB Fitters Have a Removable Electrical Tray.

### UA & UB Utility Fitters

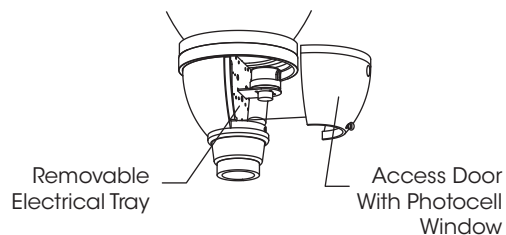

### Twist Lock Photocell Fitters

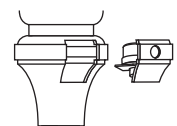

# LAFC SERIES - LED

## SAMPLE ASSEMBLIES

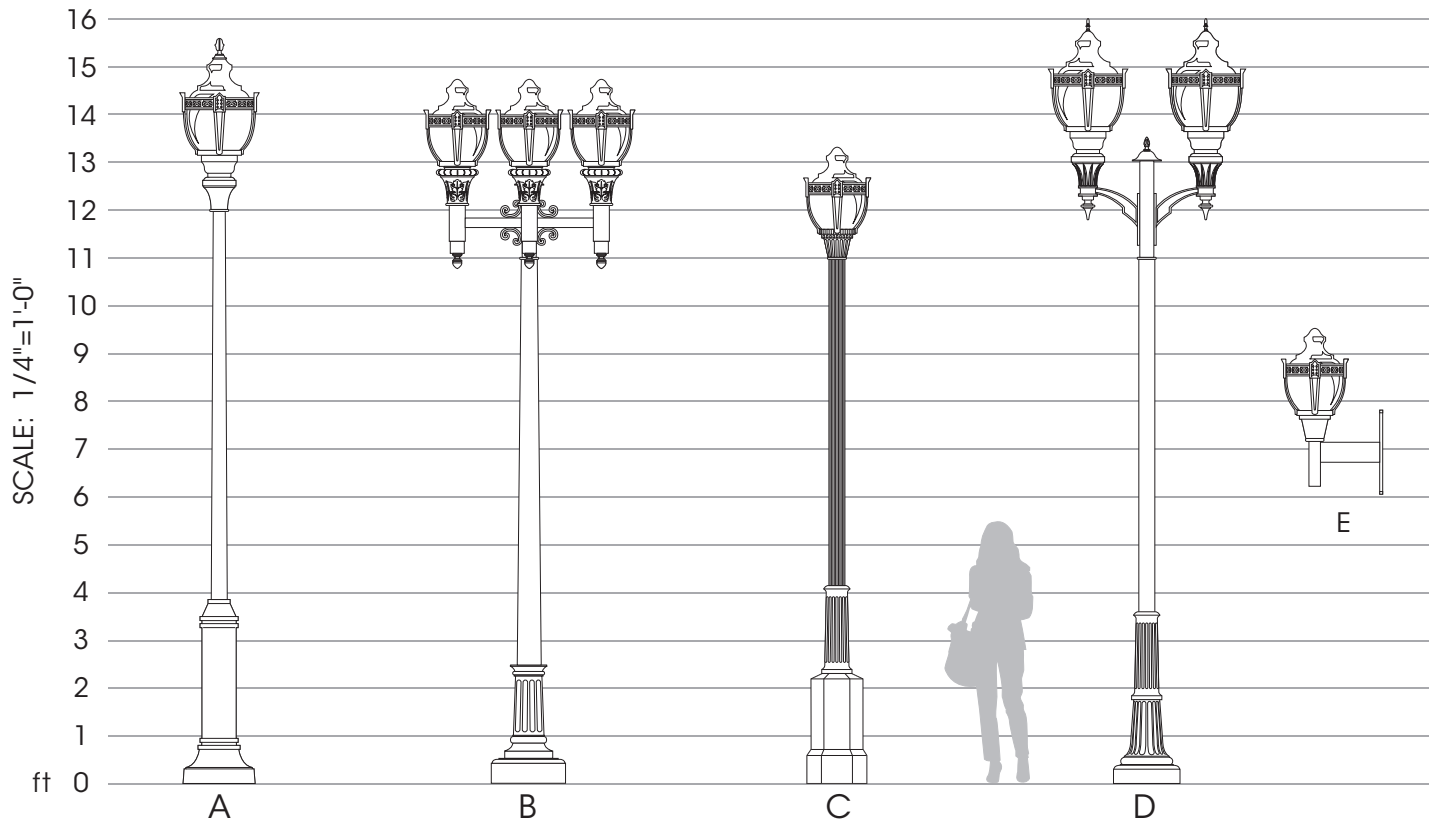

- A. 43-1030T-12'/PT/LAFC1-YD-WP-PF/LED/ACCESSORIES/FINISH
- B. 13-1046T-11'/XAJ-4-90/LAFC2-YC-CA/LED/ACCESSORIES/FINISH
- C. 16-1060-11'/PT/LAFC2-YA-CA/LED/ACCESSORIES/FINISH
- D. 3-1040-11'/XAZ-UP-2-180/LAFC1-YE-WP-BF/LED/ACCESSORIES/FINISH
- E. WM-XAL/LAFC2-YB-CA/LED/ACCESSORIES/FINISH

Sample Assemblies show a small offering of the Sun Valley Line of Poles, Bases, Shafts, Arms, & Luminaires. Please visit [usalgtg.com](http://usalgtg.com) for the full product offering.

# L AFC SERIES - LED

## OPTIONS

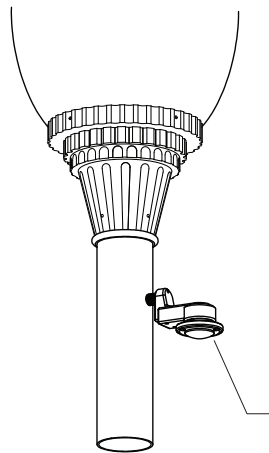
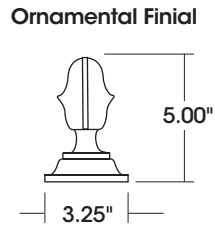
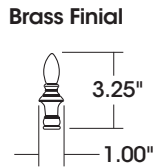

### POLE MOUNTED MFS-311 BLUETOOTH PHOTO/MOTION SENSOR

Factory Settings:  
No Motion - 50%  
Motion - 100%  
Delay - 15 min.  
Photocell - 75fc

Sensors can be Field  
Programmed With  
Bluetooth App

Coupling Provided  
on Pole to Secure  
Motion Sensor.

## INSTALLATION DETAIL

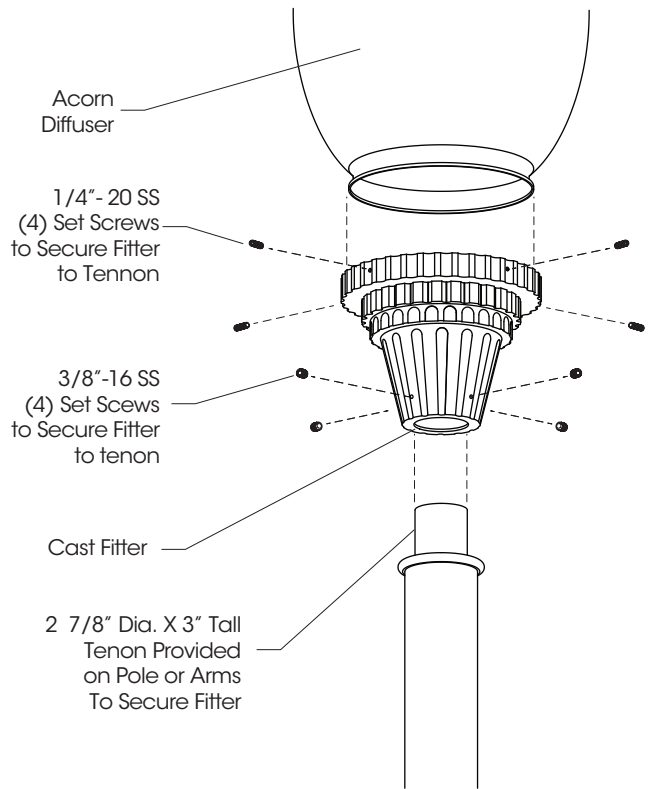

### High Low Dimming For Switches (HLSW)

The HLSW is a Small Electronic Switch which Provides High Low Dimming Control Through the LED Driver's 0-10V Control. Switching is Done by Adding a Secondary AC Switched Hot Trigger Line to the HLSW in Addition to the Normal AC Power Line. When the Secondary Trigger Line is Powered, the Fixture will go to 100% Dimming. With no Power to the Trigger, the Fixture will operate at 50% or 25% Dimming. Switches for the Trigger Line can be a Normal AC Switch/Breaker or Timed Switch/Breaker.

### Wireless and Other Fixture Controls

Contact Factory for Wireless and Other Fixture Controls and Recommendations. Most Controls Can be Integrated and Factory Installed.

## ELECTRICAL DATA GUIDE - AMPERAGE CHARTS

# of LEDs	mA	System Watts	120V	208V	277V	347V	480V
40	350	43	0.36	0.21	0.16	0.12	0.09
40	525	64	0.53	0.31	0.23	0.18	0.13
40	700	86	0.72	0.41	0.31	0.25	0.18
60	350	64	0.53	0.31	0.23	0.18	0.13
60	525	96	0.80	0.46	0.35	0.28	0.20
60	700	129	1.08	0.62	0.47	0.37	0.27
80	350	85	0.71	0.41	0.31	0.24	0.18
80	525	128	1.07	0.62	0.46	0.37	0.27
80	700	171	1.43	0.82	0.62	0.49	0.36

# of LEDs	mA	System Watts	120V	208V	277V	347V	480V
32	350	34	0.28	0.16	0.12	0.10	0.07
32	525	52	0.43	0.25	0.19	0.15	0.11
32	700	69	0.58	0.33	0.25	0.20	0.14
48	350	51	0.43	0.25	0.18	0.15	0.11
48	525	78	0.65	0.38	0.28	0.22	0.16
48	700	104	0.87	0.50	0.38	0.30	0.22
64	350	68	0.57	0.33	0.25	0.20	0.14
64	525	103	0.86	0.50	0.37	0.30	0.21
64	700	138	1.15	0.66	0.50	0.40	0.29

Electrical Loads Above are for High Power White LED's in All Color Temperatures. Use 0.80 Scale factor for TRA LED's. Wattages Above are System Watts or Total Input Watts and include all Electrical Components.

# L AFC SERIES - LED

## PHOTOMETRIC DATA GUIDE - ISOFOOTCANDLE PLOTS

### L AFC1-LED-PA2-CPA-60LED-700mA-4000K - 16' Pole Height

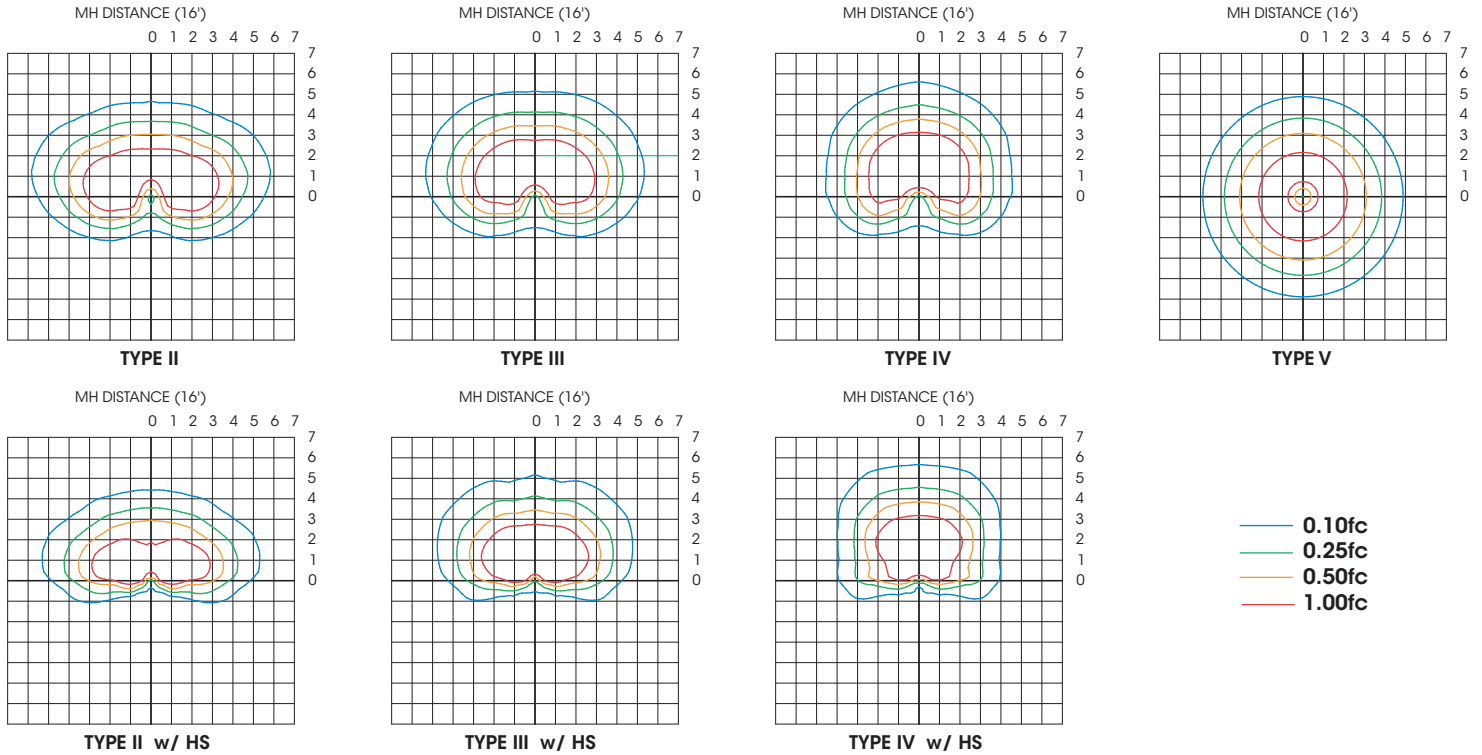

### L AFC2-LED-PA2-CPA-32LED-700mA-4000K - 12' Pole Height

