

TRADITIONAL STYLED BASE

2400 Split Base Series

Base

Two piece wraparound, corrosion resistant, durable cast aluminum construction. Minimum .225 Wall thickness. Base consists of a wide smooth bottom section, and a decorative top section provided with Hand Hole and Cover contoured to Base design. Hand Hole Cover supplied with tamper resistant hardware. (4) 1/4"-20 Set Screws provided to secure decorative Base to shaft.

Finish

Super TGIC polyester powder coating is applied onto a metal substrate this has been pretreated with a four-stage process for maximum adhesion and color retention. The top coat is baked at 400° F for maximum hardness and exterior durability.

2400SB
ORDERING INFORMATION

Spec/Order Example: 2400SB/RAL-9003-T/RBH

Base	Finish	Options
<input type="checkbox"/> 2400SB	Standard Textured Finish <input type="checkbox"/> Black RAL-9005-T <input type="checkbox"/> White RAL-9003-T <input type="checkbox"/> Grey RAL-7004-T <input type="checkbox"/> Dark Bronze RAL-8019-T <input type="checkbox"/> Green RAL-6005-T Premium Finishes <input type="checkbox"/> Rust <input type="checkbox"/> Patina Copper PC	<input type="checkbox"/> Banner Eye Bolt BEB¹ <input type="checkbox"/> Break Away Banner Arm BBA <input type="checkbox"/> Fixed Banner Arm FBA¹ <input type="checkbox"/> Field Rotatable Banner Arm RBA <input type="checkbox"/> Fixed Basket Holder FBH¹ <input type="checkbox"/> Field Rotatable Basket Holder RBH <input type="checkbox"/> Field Rotatable Street Sign RSS <input type="checkbox"/> Field Rotatable Ladder Rest RLR <input type="checkbox"/> Fixed Flag Holder FFH¹ <input type="checkbox"/> Field Rotatable Flag Holder RFH <input type="checkbox"/> Duplex GFI w/ Cover GFI¹ <input type="checkbox"/> Duplex GFI w/ In-Use Cover GFHU¹
	For smooth finish replace suffix "T" with suffix "S" (Example: RAL-9500-S) Consult factory for custom colors	1- available only with the purchase of a new pole assembly from our factories. *Field* options must specify the diameter of the pole (4" to 6" Dia. max.)

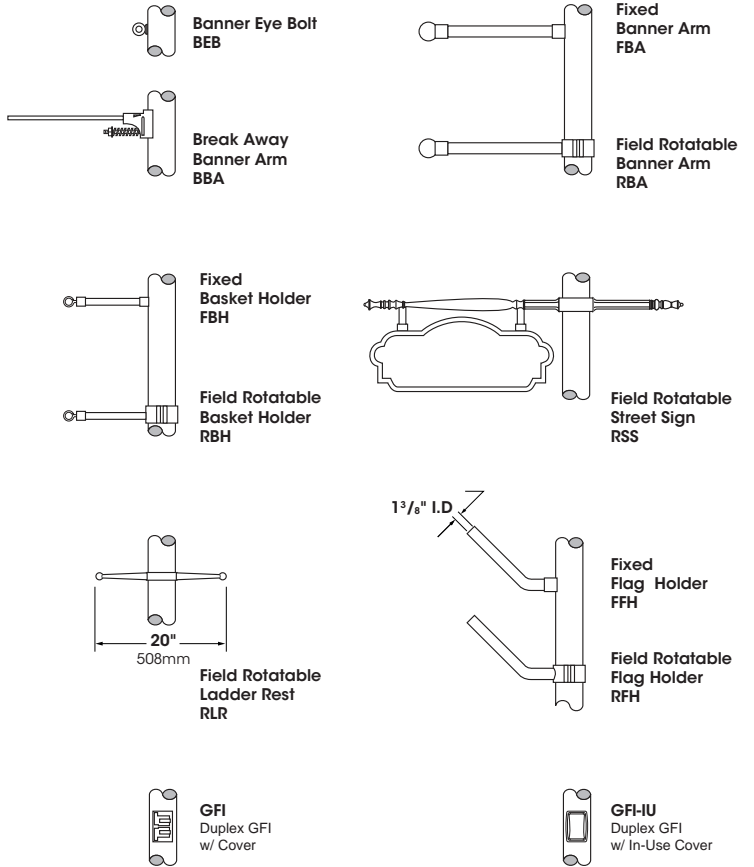
OPTIONS

<https://www.usaltg.com/downloads/pdf/Pole-Arm-Accessories.pdf>

2024136

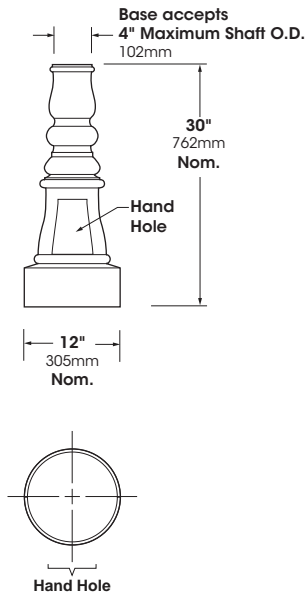
DIMENSIONS



Note: Anchor Plate for Pole Assembly used with this decorative 2-pc Base must fit inside a 11" dia.

SAMPLE ASSEMBLIES

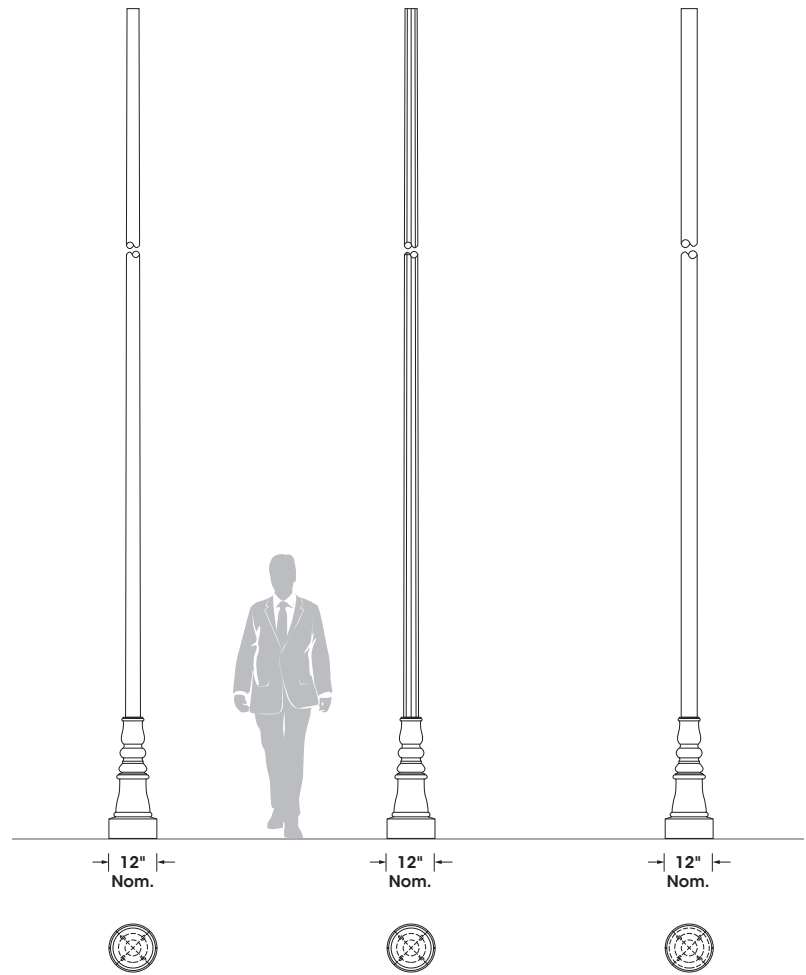

SCALE: 1/4"=1'-0"

Sample Assemblies show small offering of Sun Valley's line of Poles & Shafts. Please visit usalgtg.com for full product catalog.