

# 3900SB

## SPLIT BASE

3900SB

### BASE

TWO PIECE WRAPAROUND, CORROSION RESISTANT, DURABLE CAST ALUMINUM CONSTRUCTION. MINIMUM .225 WALL THICKNESS. BASE CONSISTS OF WIDE SMOOTH STEPPED BOTTOM SECTION AND A DECORATIVE TOP SECTION PROVIDED WITH HAND HOLE AND COVER. HAND HOLE COVER SUPPLIED WITH TAMPER RESISTANT HARDWARE. (4) 1/4"-20 SET SCREWS PROVIDED TO SECURE DECORATIVE BASE TO SHAFT.

### FINISH

ELECTROSTATICALLY APPLIED BAKED ON TEXTURED ACRYLIC ENAMEL. (SEE PAGE 5 FOR OPTIONAL FINISH AND COLOR SELECTION)

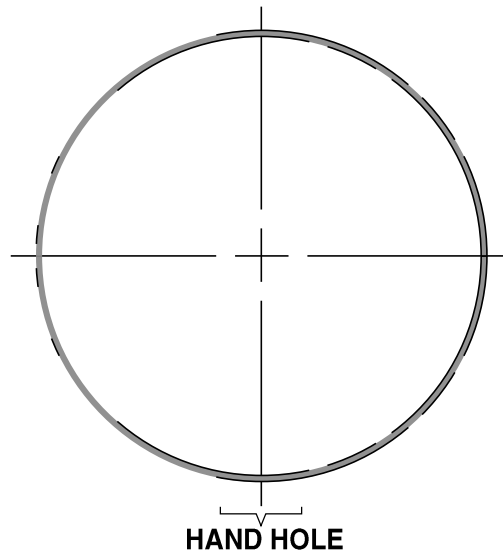
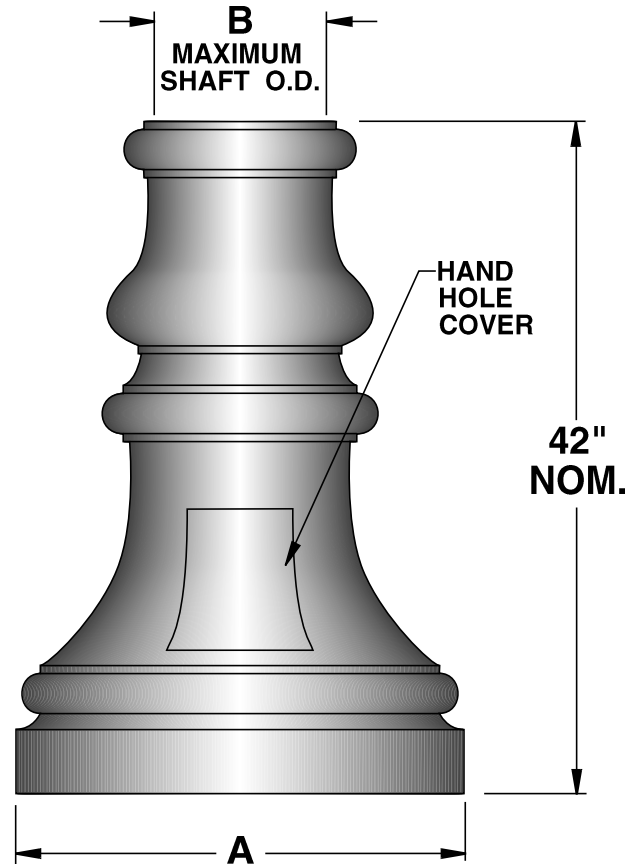

BASE CATALOG NO.	"A"	"B"
3900SB-A	24 1/2"	8"
3900SB-B	28"	10 3/4"
3900SB-C	30"	12 1/4"
3900SB-D	31"	14 1/2"



**sun valley**  
LIGHTING

660 WEST AVENUE O, PALMDALE, CA 93551  
(661) 233-2000  
FAX (661) 233-2001  
www.sunvalleylighting.com

SB-19

### ACCESSORIES

(SPECIFY AS SUFFIX TO CAT. NO.)

#### TENONS

- 2 3/8" O.D.  PT23
- 2 7/8" O.D.  PT27
- 3 1/2" O.D.  PT31

- DUPLEX OR G.F.I. RECEPTACLE WITH COVER  DUP  
GFI

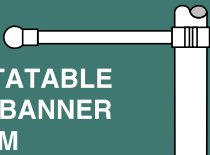
- FIELD ROTATABLE OR FIXED BANNER ARM  RBA  
FBA

- BANNER EYE BOLT  BEB

- BREAK AWAY BANNER ARM  BBA

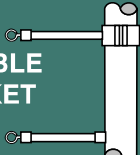
- FIELD ROTATABLE OR FIXED BASKET HOLDER  RBH  
FBH

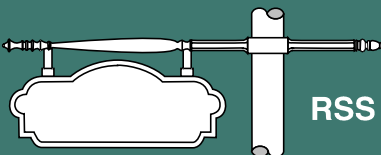
- FIELD ROTATABLE STREET SIGN  RSS

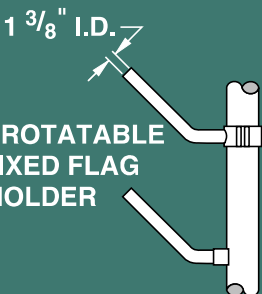
- FIELD ROTATABLE OR FIXED FLAG HOLDER  RFH  
FFH

SCALE: 1/2"=1'-0"

