

SOLID STATE AREA LIGHTING

CIRCULUX SERIES-LED

S P E C I F I C A T I O N S

LUMINAIRE

One piece high impact polycarbonate lens provided with durable corrosion resistant cast aluminum fitter base. Heavy gauge formed aluminum reflector. Top is hinged for access. Base has 3" I.D. opening for tenon mounting. All hardware is Stainless Steel.

LED POWER ARRAY™

Three-dimensional array of individual LED Tubes fastened to a retaining plate. Each LED Tube consists of circuit board populated with a multiple of LED's and is mechanically fastened to a radial aluminum heat sink. An acrylic Lens and end cap protects the LED Tube's internal components.

VERTICAL POWER ARRAY™ WITH GLASS REFRACTOR:

LED Tubes are aligned vertically and arranged radially to produce an even raw light distribution that simulates standard light sources. Array is secured within a 6" Prismatic Glass Refractor which provides the optical control. Used in conjunction with a clear smooth globe.

VERTICAL POWER ARRAY™: LED Tubes are aligned vertically and arranged radially to produce an even raw light distribution that simulates standard light sources. Produces a minimal glare, symmetric diffuse light distribution. Used in conjunction with an opal smooth diffusing globe.

LED EMITTERS

High Output LED's are driven at 350mA for nominal 1 Watt output each. LED's are available in standard Neutral White (4000K), or optional Cool White (5000K) or Warm White (3000K). Consult Factory for other LED options.

LED DRIVER

UL and CUL recognized High Power Factor, Constant Current LED drivers operate on input voltages from 120-277VAC, 50/60hz. Consult Factory for 347-480VAC. Driver is mechanically fastened to a retaining bracket. Main power quick disconnect provided. Driver has a minimum 4KV of internal surge protection, 10KV & 20KV Surge Protector optional. Dimming and High-Low Driver options available.

FINISH

Polyester powder coat incorporates four step iron phosphate process to pretreat metal surface for maximum adhesion. Top coat is baked at 400°F for maximum hardness and exterior durability.

PROJECT NAME: _____

PROJECT TYPE: _____

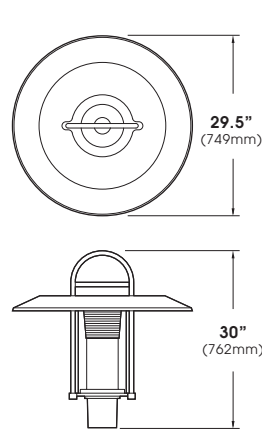

CLX

PATENT PENDING

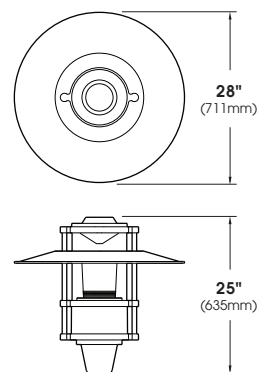

CLXA

PATENT PENDING



2014149

CIRCULUX SERIES - LED

S P E C I F I C A T I O N S

WALL MOUNT

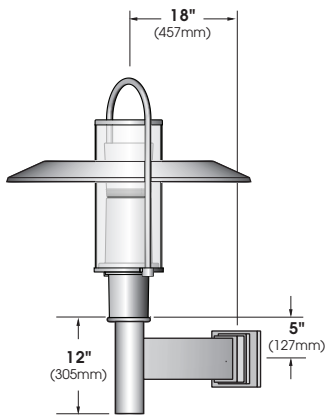

EXTRUDED ALUMINUM ARM BRACKET AND CAST ALUMINUM WALL BRACKET ASSEMBLY PROVIDED WITH BUILT IN GASKETED WIRE ACCESS FOR FIXTURE/SUPPLY WIRE CONNECTION.

WALL PLATE

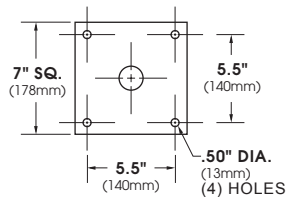

LED POWER ARRAY™ MODULES

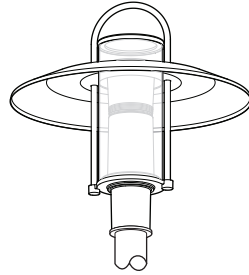

CLX-LED E.P.A.= 1.28

GLASS REFRACTOR w/ VERTICAL ARRAY
Available in:
6 Array 36 LED Max.

VERTICAL ARRAY
Available in:
6 Array 48 LED Max.
8 Array 64 LED Max.

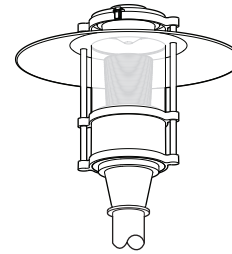

CLXA-LED E.P.A.= 1.44

GLASS REFRACTOR w/ VERTICAL ARRAY
Available in:
6 Array 36 LED Max.

VERTICAL ARRAY
Available in:
6 Array 48 LED Max.
8 Array 64 LED Max.

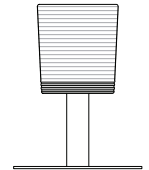

GRV - Glass Refractor w/ Vertical Array
Base mount

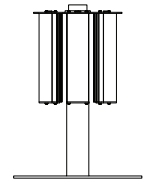

VPA - Vertical Array
Base mount

(Specifications subject to change without prior notice.)

PATENT PENDING

S P E C / O R D E R I N G I N F O R M A T I O N

LUMINAIRE	OPTICS	# of LED's	COLOR	VOLTAGE	MOUNTING	FINISH	OPTIONS
LUMINAIRE	OPTICS	LED			MOUNTING	FINISH	OPTIONS
<input type="checkbox"/> CLX-LED <input type="checkbox"/> CLXA-LED	GLASS REFRACTOR (CLEAR SMOOTH LENS) <input type="checkbox"/> GRV - III <input type="checkbox"/> GRV - V VERTICAL POWER ARRAY (OPAL SMOOTH LENS) <input type="checkbox"/> VPA - SYM	No. LEDs <input type="checkbox"/> 36LED (41 Watts) Wattages are Max Input Watts <input type="checkbox"/> 64LED (72 Watts) <input type="checkbox"/> 48LED (53 Watts) <input type="checkbox"/> 36LED (41 Watts) Wattages are Max Input Watts	<input type="checkbox"/> NW (4000K)* *STANDARD <input type="checkbox"/> CW (5000K) <input type="checkbox"/> WW (3000K) OTHER LED COLORS AVAILABLE CONSULT FACTORY	<input type="checkbox"/> 120 <input type="checkbox"/> 208 <input type="checkbox"/> 240 <input type="checkbox"/> 277 <input type="checkbox"/> 347 <input type="checkbox"/> 480	ARM MOUNT <input type="checkbox"/> 1 <input type="checkbox"/> 2-180 <input type="checkbox"/> 2-90 <input type="checkbox"/> 3-90 <input type="checkbox"/> 3-120 <input type="checkbox"/> 4-90 WALL MOUNT <input type="checkbox"/> WM POST TOP <input type="checkbox"/> PT	STANDARD TEXTURED FINISH <input type="checkbox"/> BLACK RAL-9005-T <input type="checkbox"/> WHITE RAL-9003-T <input type="checkbox"/> GREY RAL-7004-T <input type="checkbox"/> DARK BRONZE RAL-8019-T <input type="checkbox"/> GREEN RAL-6005-T FOR SMOOTH FINISH REPLACE SUFFIX "T" WITH REPLACE "S" (EXAMPLE: RAL-9500-S) SEE USALTG.COM FOR ADDITIONAL COLORS	LENS OPTIONS: <input type="checkbox"/> CLEAR SANDBLASTED POLYCARBONATE. . . CSP (STANDARD LENS) <input type="checkbox"/> CLEAR SANDBLASTED ACRYLIC. CSA <input type="checkbox"/> CLEAR SMOOTH POLYCARBONATE . . . CP <input type="checkbox"/> CLEAR SMOOTH ACRYLIC. CA <input type="checkbox"/> OPAL SMOOTH POLYCARBONATE . . . WP <input type="checkbox"/> OPAL SMOOTH ACRYLIC. WA <input type="checkbox"/> HOUSE SIDE SHIELD. . . HS <input type="checkbox"/> DIMMABLE DRIVER(S) (0-10V). DIM <input type="checkbox"/> HIGH-LOW DIMMING FOR HARDWIRED SWITCHING OR NON-INTEGRATED MOTION SENSOR HLSW <input type="checkbox"/> PHOTO CELL + VOLTAGE (EXAMPLE: PC120V) . . . PC+V <input type="checkbox"/> 10KV SURGE PROTECTOR. 10SP <input type="checkbox"/> 20KV SURGE PROTECTOR (240V & 480V Only) . . . 20SP