

SOLID STATE LIGHTING

COLONIAL

WALL MOUNT - PLED

Fixture Housing

Hub, Cage, and Top (Hood) consist of cast low copper (A356 alloy; < 0.2%Cu) aluminum. Hood is fastened to the top of the Cage with a stainless steel hinge and secured with a single stainless steel hex head cap screw 180° opposite the hinge. Hood and Cage are sealed with an extruded closed cell silicone gasket. Cage is welded to the Hub with blended or concealed weldments to create an open frame appearance. Driver/wiring accessed through top of Electrical Access Hub. All exposed hardware is stainless steel. Optical Assembly secures in Hood.

Arm

One piece unitized arm and Wall Mount plate consisting of cast low copper (A356 alloy; < 0.2% Cu) aluminum. Arm is welded to the Wall Mount plate and entire Arm/Wall Mount assembly is either welded to the COL12 Hood (WM-P) or mechanically fastened to the Hub (WM-T). All welds are blended to create a homogeneous appearance. Wall Mount plate affixed to mounting surface covering a recessed j-box.

PLED™ Optics

Emitters (LED's) are arrayed on a metal core PCB panel with each emitter located on a copper thermal transfer pad and enclosed by an LED refractor. In asymmetric distributions, a micro-reflector inside the refractor re-directs the house side emitter output towards the street side and functions as a house side shielding element. Refractors are injection molded H12 acrylic. Each LED refractor is sealed to the PCB over an emitter and all refractors are retained by an aluminum frame. LED refractors produce standard asymmetric site/area distributions. Panels are field replaceable and field rotatable in 90° increments.

LED Driver(s)

Constant current electronic with a power factor of >.90 and a minimum operating temperature of -40°F. Driver(s) is/are UL and cUL recognized. In-line terminal blocks facilitate wiring between the driver and optical arrays. Drivers accept an input of 120-277V, 50/60Hz or 347V-480V, 50,60Hz. (0 - 10V dimmable driver is standard. Driver has a minimum of 3KV internal surge protection. Luminaire supplied with 20KV surge protector for field accessible installation.)

LED Emitters

High output LED's are utilized with drive currents ranging from 175mA to 525mA. 70CRI Minimum. LED's are available in standard Neutral White (4000K), or optional Cool White (5000K) or Warm White (3000K). Consult Factory for other LED options.

Amber LED's

PCA (Phosphor Converted Amber) LED's utilize phosphors to create color output similar to LPS lamps and have a slight output in the blue spectral bandwidth. TRA (True Amber) LED's utilize material that emits light in the amber spectral bandwidth only without the use of phosphors.

Finish

Super TGIC polyester powder coating is applied onto a metal substrate this has been pretreated with a four-stage process for maximum adhesion and color retention. The top coat is baked at 400° F for maximum hardness and exterior durability.

PROJECT NAME: _____

FIXTURE TYPE: _____

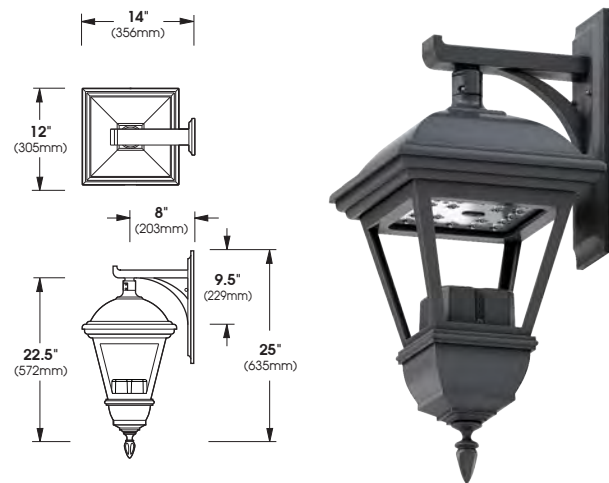
COL12/XCA-UT (Post Top Mount)

COL12/XCA-UP (Pendant Mount)

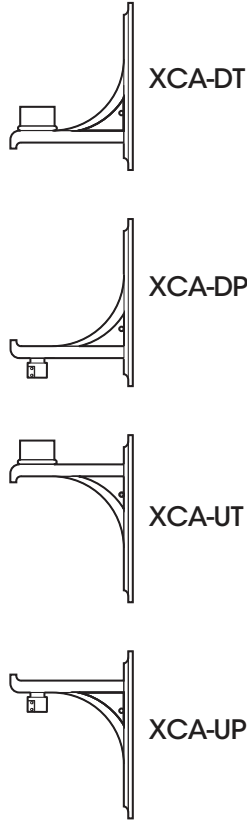
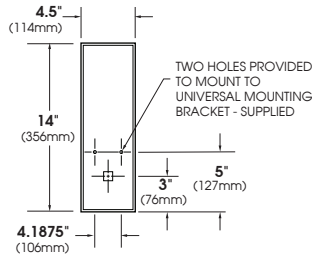

2023010

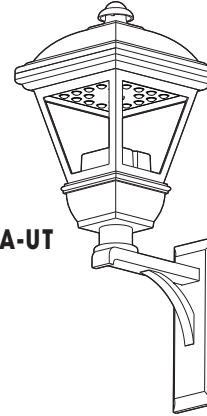
SPECIFICATIONS
MOUNTING OPTIONS

WALL PLATE



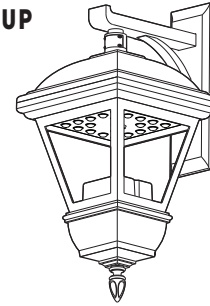



MOUNTING HARDWARE BY OTHERS.

PLED™ MODULES

COL12/XCA-UT
 E.P.A. = .94
 Available in:
 20 LED Max.

20 LED MODULE

COL12/XCA-UP
 E.P.A. = .82
 Available in:
 20 LED Max.

ORDERING INFORMATION

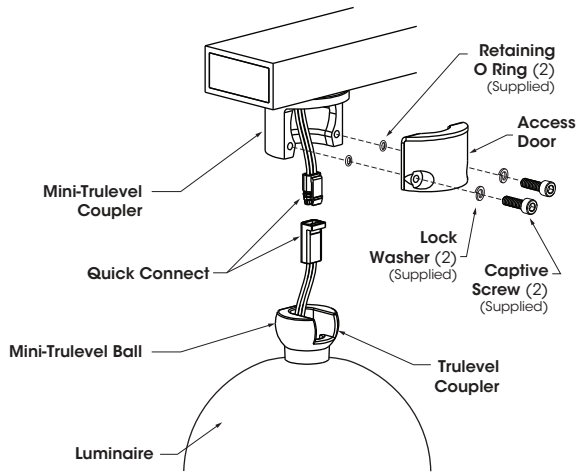
Spec/Order Example: COL12/XCA-UP/PLED-III M/20LED-450mA/NW/277V/RAL-9005-T/PC+V

Luminaire & Mounting	Optics	# of LED's	Drive Current	Color	Voltage	Finish	Options
Luminaire & Mounting	Optics	LED		Voltage	Finish	Options	
<input type="checkbox"/> COL12/XCA-DT <input type="checkbox"/> COL12/XCA-DP <input type="checkbox"/> COL12/XCA-UT <input type="checkbox"/> COL12/XCA-UP	PLED™ Distribution Type <input type="checkbox"/> TYPE II PLED-II  <input type="checkbox"/> TYPE II FRONT ROW PLED-II-FR  <input type="checkbox"/> TYPE III MED. PLED-III-M  <input type="checkbox"/> TYPE III WIDE PLED-III-W  <input type="checkbox"/> TYPE IV PLED-IV  <input type="checkbox"/> TYPE IV PLED-IV-FT 	<input type="checkbox"/> 20LED	<input type="checkbox"/> 175mA <input type="checkbox"/> 350mA <input type="checkbox"/> 450mA <input type="checkbox"/> 525mA	Color Temp-CCT <input type="checkbox"/> NW (4000K) *STANDARD <input type="checkbox"/> CW (5000K) <input type="checkbox"/> WW (3000K) OTHER LED COLORS AVAILABLE CONSULT FACTORY <input type="checkbox"/> AMBER ¹ <input type="checkbox"/> PHOSPHOR CONVERTED AMBER PCA <input type="checkbox"/> TRUE AMBER TRA	Voltage <input type="checkbox"/> 120 <input type="checkbox"/> 208 <input type="checkbox"/> 240 <input type="checkbox"/> 277 <input type="checkbox"/> 347 <input type="checkbox"/> 480	Standard Textured Finish <input type="checkbox"/> BLACK RAL-9005-T <input type="checkbox"/> WHITE RAL-9003-T <input type="checkbox"/> GREY RAL-7004-T <input type="checkbox"/> DARK BRONZE RAL-8019-T <input type="checkbox"/> GREEN RAL-6005-T For smooth finish replace suffix "T" with suffix "S" (Example: RAL-9500-S) Consult factor for custom colors	<input type="checkbox"/> HOUSE SIDE SHIELDS... HS-PLED <input type="checkbox"/> HIGH-LOW DIMMING FOR HARDWIRED SWITCHING OR NON-INTEGRATED MOTION SENSOR HLSW <input type="checkbox"/> PHOTO CELL + VOLTAGE (EXAMPLE: PC120V) PC+V <input type="checkbox"/> SINGLE FUSE (120V, 277V) SF <input type="checkbox"/> DOUBLE FUSE (208V, 240V) DF CONTACT FACTORY FOR STEP DIM MOTION SENSOR (PROGRAMMED 25-50/100)
NOTES: 1 - NARROW BAND AMBERS HAVE NO DEFINABLE CCT EQUIVALENT							

INSTALLATION DETAIL
Mini-Trulevel System® Assembly

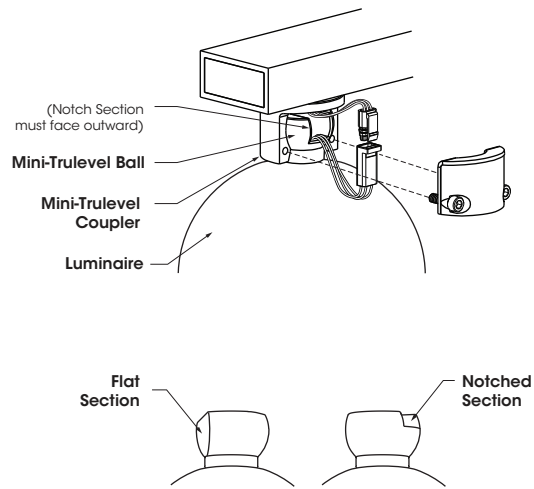
1. Loosen (2) Captive Screws and remove Access Door from Mini-Trulevel Coupler, pull out Quick Connect from Mini-Trulevel Coupler and Mini-Trulevel Ball.



2. Place Mini-Trulevel Ball inside of Mini-Trulevel Coupler as illustrated.

A - Notched Section of Mini-Trulevel Ball must face outward as illustrated.

B - Flat Section of Mini-Trulevel Ball must face inward.

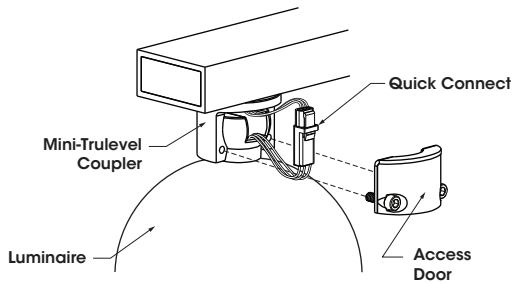

3. Connect Quick Connect components, push components inside of Mini-Trulevel Coupler cavity, replace Access Door and loosely secure, do not tighten.

Fixture will suspend without Access Door during installation.

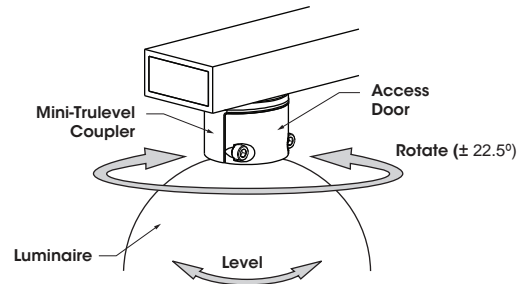

4. Rotate (left to right $\pm 22.5^\circ$) and level Luminaire to desired position. Tighten Access Door.

(Tighten each bolt to recommended torque: **10 ft-lb, foot-pound**)

Mini-Trulevel Pendant Mount is intended to allow for fixture leveling, but is not intended to be "free-swinging" upon proper installation.

ELECTRICAL GUIDE

LED COUNT	SOURCE TYPE	SOURCE	INITIAL LUMENS - 4000K	INITIAL LUMENS - 3000K	INITIAL LUMENS - 5000K	L70 GREATER THAN (HR)-TM21	STARTING TEMP.	SYSTEM WATTS	VOLTS	MAX INPUT AMPS
20	LED	20 PLED® Optical Module - 175mA	1,141 - 1,257	1,084 - 1,194	1,198 - 1,320	85,000+	-20°F	11	120 277	0.09 0.04
20	LED	20 PLED® Optical Module - 350mA	2,074 - 2,285	1,970 - 2,171	2,178 - 2,399	85,000+	-20°F	22	120 277	0.18 0.09
20	LED	20 PLED® Optical Module - 450mA	2,564 - 2,824	2,435 - 2,683	2,692 - 2,966	85,000+	-20°F	29	120 277	0.23 0.10
20	LED	20 PLED® Optical Module - 525mA	2,987 - 3,290	2,837 - 3,126	3,136 - 3,455	85,000+	-20°F	33	120 277	0.27 0.12

NOTES:

1. Max Input Amps is the highest of starting, operating, or open circuit currents
2. Lumen values for LED Modules vary according to the distribution type
3. System Watts includes the source watts and all driver components.
4. Fuse value should be sufficient to protect all wiring components. For electronic driver and LED component protection, use 10KV - 20KV surge suppressors.
5. L70(14K) - TM-21 6x rule applied

WARNING: All fixtures must be installed in accordance with local codes or the National Electrical Code. Failure to do so may result in serious personal injury.

SOLID STATE LIGHTING

COLONIAL - CPA

WALL MOUNT - PLED

Fixture Housing

Hub, Cage, and Top (Hood) consist of cast low copper (A356 alloy; < 0.2%Cu) aluminum. Hood is fastened to the top of the Cage with a stainless steel hinge and secured with a single stainless steel hex head cap screw 180° opposite the hinge. Cage retains four Clear Patterned Acrylic lenses. Hood and Cage are sealed with an extruded closed cell silicone gasket. Cage is welded to the Hub with blended or concealed weldments. Driver/wiring accessed through top of Electrical Access Hub. All exposed hardware is stainless steel. Optical Assembly secures in Hood.

Arm

One piece unitized arm and Wall Mount plate consisting of cast low copper (A356 alloy;<0.2% Cu) aluminum. Arm is welded to the Wall Mount plate and entire Arm/Wall Mount assembly is either welded to the COL12 Hood (WM-P) or mechanically fastened to the Hub (WM-T). All welds are blended to create a homogeneous appearance. Wall Mount plate affixed to mounting surface covering a recessed j-box.

PLED™ Optics

Emitters (LED's) are arrayed on a metal core PCB panel with each emitter located on a copper thermal transfer pad and enclosed by an LED refractor. In asymmetric distributions, a micro-reflector inside the refractor re-directs the house side emitter output towards the street side and functions as a house side shielding element. Refractors are injection molded H12 acrylic. Each LED refractor is sealed to the PCB over an emitter and all refractors are retained by an aluminum frame. LED refractors produce standard asymmetric site/area distributions. Panels are field replaceable. Housing frame retains Clear Patterned Acrylic diffusing panels.

LED Driver(s)

Constant current electronic with a power factor of >.90 and a minimum operating temperature of -40°F. Driver(s) is/are UL and cUL recognized. In-line terminal blocks facilitate wiring between the driver and optical arrays. Drivers accept an input of 120-277V, 50/60Hz or 347V-480V, 50,60Hz. (0 - 10V dimmable driver is standard. Driver has a minimum of 3KV internal surge protection. Luminaire supplied with 20KV surge protector for field accessible installation.)

LED Emitters

High output LED's are utilized with drive currents ranging from 175mA to 525mA. 70CRI Minimum. LED's are available in standard Neutral White (4000K), or optional Cool White (5000K) or Warm White (3000K). Consult Factory for other LED options.

Amber LED's

PCA (Phosphor Converted Amber) LED's utilize phosphors to create color output similar to LPS lamps and have a slight output in the blue spectral bandwidth. TRA (True Amber) LED's utilize material that emits light in the amber spectral bandwidth only without the use of phosphors.

Finish

Super TGIC polyester powder coating is applied onto a metal substrate this has been pretreated with a four-stage process for maximum adhesion and color retention. The top coat is baked at 400° F for maximum hardness and exterior durability.

PROJECT NAME: _____

FIXTURE TYPE: _____

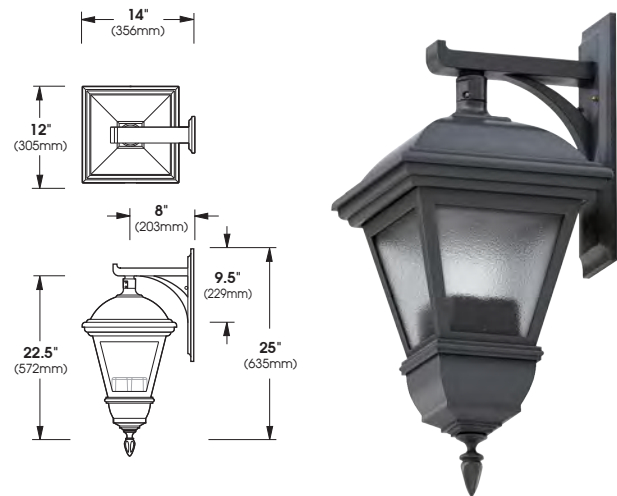
COL12-CPA/XCA-UT(Post Top Mount)

COL12-CPA/XCA-UP (Pendant Mount)

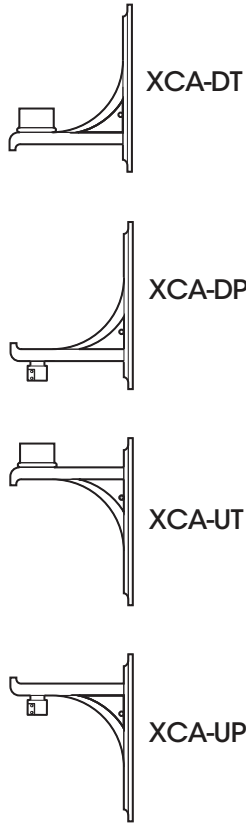

2023010

SPECIFICATIONS

MOUNTING OPTIONS

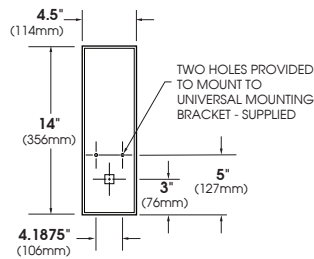

WALL PLATE



MOUNTING HARDWARE BY OTHERS.

PLED™ MODULES

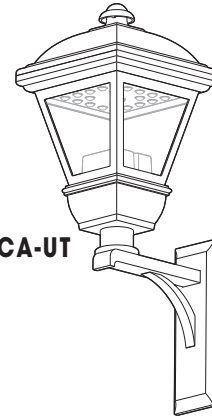

COL12-CPA/XCA-UT
E.P.A.= .94
Available in:
20 LED Max.



20 LED MODULE

COL12-CPA/XCA-UP
E.P.A.= .82
Available in:
20 LED Max.

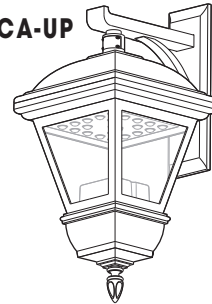

ORDERING INFORMATION

Spec/Order Example: COL12-CPA/XCA-UP/PLED-III M/20LED-350mA/NW/277V/RAL-9005-T/PC+V

Luminaire & Mounting	Optics	# of LED's	Drive Current	Color	Voltage	Finish	Options
Luminaire & Mounting	Optics	LED		Color Temp-CCT	Voltage	Finish	Options
	PLED™ Distribution Type	# of LED's	Drive Current	Color Temp-CCT	Voltage	Standard Textured Finish	
<input type="checkbox"/> COL12-CPA/XCA-DT	<input type="checkbox"/> TYPE II PLED-II	<input type="checkbox"/> 20LED	<input type="checkbox"/> 175mA	<input type="checkbox"/> NW (4000K) * STANDARD	<input type="checkbox"/> 120	<input type="checkbox"/> BLACK RAL-9005-T	<input type="checkbox"/> HOUSE SIDE SHIELDS¹ . . . HS-PLED¹
<input type="checkbox"/> COL12-CPA/XCA-DP	<input type="checkbox"/> TYPE II FRONT ROW PLED-II-FR		<input type="checkbox"/> 350mA	<input type="checkbox"/> CW (5000K)	<input type="checkbox"/> 208	<input type="checkbox"/> WHITE RAL-9003-T	<input type="checkbox"/> HIGH-LOW DIMMING FOR HARDWIRED SWITCHING OR NON-INTEGRATED MOTION SENSOR HLSW
<input type="checkbox"/> COL12-CPA/XCA-UT	<input type="checkbox"/> TYPE III MED. PLED-III-M		<input type="checkbox"/> 450mA	<input type="checkbox"/> WW (3000K)	<input type="checkbox"/> 240	<input type="checkbox"/> GREY RAL-7004-T	<input type="checkbox"/> PHOTO CELL + VOLTAGE (EXAMPLE: PC120V) PC+V
<input type="checkbox"/> COL12-CPA/XCA-UP	<input type="checkbox"/> TYPE III WIDE PLED-III-W		<input type="checkbox"/> 525mA	OTHER LED COLORS AVAILABLE CONSULT FACTORY	<input type="checkbox"/> 277	<input type="checkbox"/> DARK BRONZE RAL-8019-T	<input type="checkbox"/> SINGLE FUSE (120V, 277V) SF
	<input type="checkbox"/> TYPE IV PLED-IV			AMBER¹	<input type="checkbox"/> 347	<input type="checkbox"/> GREEN RAL-6005-T	<input type="checkbox"/> DOUBLE FUSE (208V, 240V) DF
	<input type="checkbox"/> TYPE IV PLED-IV-FT			<input type="checkbox"/> PHOSPHOR CONVERTED AMBER PCA	<input type="checkbox"/> 480		
				<input type="checkbox"/> TRUE AMBER TRA		For smooth finish replace suffix "T" with suffix "S" (Example: RAL-9500-S)	NOTE: ¹- HOUSESIDE SHIELDS ARE MOUNTED ON THE PLED PANEL INTERNAL TO THE CPA LENSES
	NOTE: CLEAR PATTERNED ACRYLIC LENSES WILL IMPACT DISTRIBUTION PATTERNS AS COMPARED TO OPEN FRAME MODELS. (SEE RELATED IES FILES)			NOTES: 1- NARROW BAND AMBERS HAVE NO DEFINABLE CCT EQUIVALENT		Consult factor for custom colors	CONTACT FACTORY FOR STEP DIM MOTION SENSOR (PROGRAMMED 25-50/100)

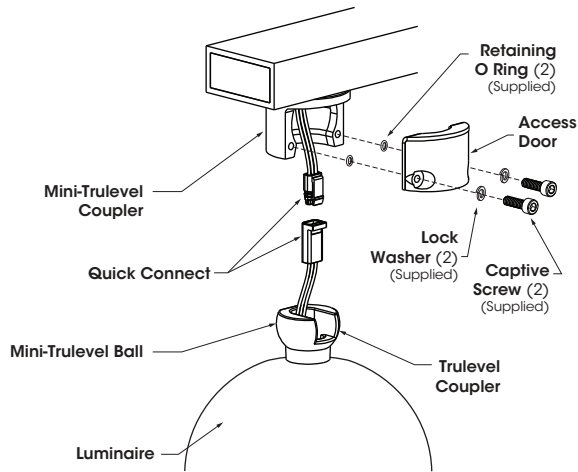
INSTALLATION DETAIL
Mini-Trulevel System® Assembly

1. Loosen (2) Captive Screws and remove Access Door from Mini-Trulevel Coupler, pull out Quick Connect from Mini-Trulevel Coupler and Mini-Trulevel Ball.

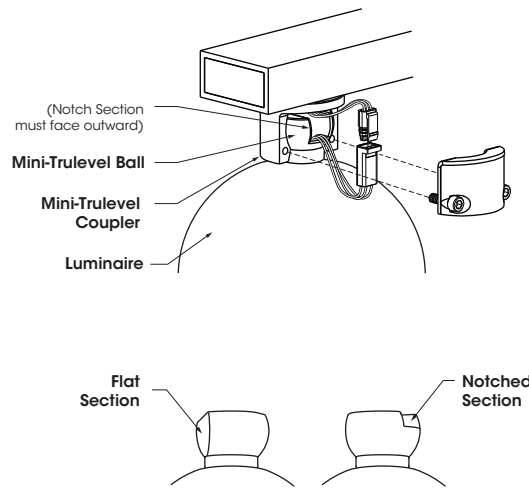

2. Place Mini-Trulevel Ball inside of Mini-Trulevel Coupler as illustrated.

A - Notched Section of Mini-Trulevel Ball must face outward as illustrated.

B - Flat Section of Mini-Trulevel Ball must face inward.

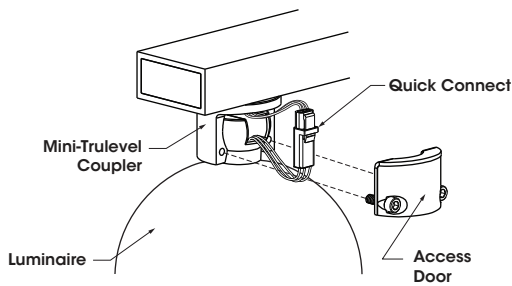

3. Connect Quick Connect components, push components inside of Mini-Trulevel Coupler cavity, replace Access Door and loosely secure, do not tighten.

Fixture will suspend without Access Door during installation.

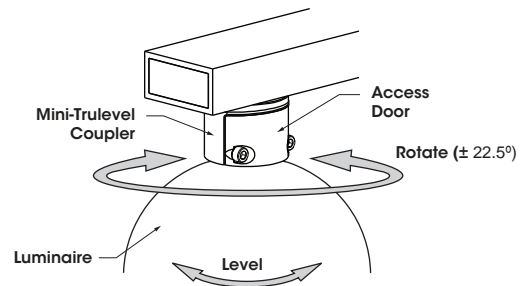

4. Rotate (left to right $\pm 22.5^\circ$) and level Luminaire to desired position. Tighten Access Door.

(Tighten each bolt to recommended torque: **10 ft-lb, foot-pound**)

Mini-Trulevel Pendant Mount is intended to allow for fixture leveling, but is not intended to be "free-swinging" upon proper installation.

ELECTRICAL GUIDE

LED COUNT	SOURCE TYPE	SOURCE	INITIAL LUMENS - 4000K	INITIAL LUMENS - 3000K	INITIAL LUMENS - 5000K	L70 GREATER THAN (HR)-TM21	STARTING TEMP.	SYSTEM WATTS	VOLTS	MAX INPUT AMPS
20	LED	20 PLED® Optical Module - 175mA	1,078 - 1,198	1,024 - 1,138	1,132 - 1,258	85,000+	-20°F	11	120 277	0.09 0.04
20	LED	20 PLED® Optical Module - 350mA	1,960 - 2,178	1,862 - 2,069	2,058 - 2,287	85,000+	-20°F	22	120 277	0.18 0.09
20	LED	20 PLED® Optical Module - 450mA	2,427 - 2,697	2,305 - 2,562	2,548 - 2,831	85,000+	-20°F	29	120 277	0.23 0.10
20	LED	20 PLED® Optical Module - 525mA	2,828 - 3,143	2,687 - 2,986	2,969 - 3,300	85,000+	-20°F	33	120 277	0.27 0.12

NOTES:

1. Max Input Amps is the highest of starting, operating, or open circuit currents
2. Lumen values for LED Modules vary according to the distribution type
3. System Watts includes the source watts and all driver components.
4. Fuse value should be sufficient to protect all wiring components. For electronic driver and LED component protection, use 10KV - 20KV surge suppressors.
5. L70(14K) - TM-21 6x rule applied

WARNING: All fixtures must be installed in accordance with local codes or the National Electrical Code. Failure to do so may result in serious personal injury.

SOLID STATE LIGHTING

COLONIAL - WA

WALL MOUNT - PLED

Fixture Housing

Hub, Cage, and Top (Hood) consist of cast low copper (A356 alloy; < 0.2%Cu) aluminum. Hood is fastened to the top of the Cage with a stainless steel hinge and secured with a single stainless steel hex head cap screw 180° opposite the hinge. Cage retains four white acrylic lenses. Hood and Cage are sealed with an extruded closed cell silicone gasket. Cage is welded to the Hub with blended or concealed weldments. Driver/wiring accessed through top of Electrical Access Hub. All exposed hardware is stainless steel. Optical Assembly secures in Hood.

Arm

One piece unitized arm and Wall Mount plate consisting of cast low copper (A356 alloy; < 0.2% Cu) aluminum. Arm is welded to the Wall Mount plate and entire Arm/Wall Mount assembly is either welded to the COL12 Hood (WM-P) or mechanically fastened to the Hub (WM-T). All welds are blended to create a homogeneous appearance. Wall Mount plate affixed to mounting surface covering a recessed j-box.

PLED™ Optics

Emitters (LED's) are arrayed on a metal core PCB panel with each emitter located on a copper thermal transfer pad and enclosed by an LED refractor. In asymmetric distributions, a micro-reflector inside the refractor re-directs the house side emitter output towards the street side and functions as a house side shielding element. Refractors are injection molded H12 acrylic. Each LED refractor is sealed to the PCB over an emitter and all refractors are retained by an aluminum frame. Housing frame retains white acrylic diffusing panels.

LED Driver(s)

Constant current electronic with a power factor of >.90 and a minimum operating temperature of -40°F. Driver(s) is/are UL and cUL recognized. In-line terminal blocks facilitate wiring between the driver and optical arrays. Drivers accept an input of 120-277V, 50/60Hz or 347V-480V, 50,60Hz. (0 - 10V dimmable driver is standard. Driver has a minimum of 3KV internal surge protection. Luminaire supplied with 20KV surge protector for field accessible installation.)

LED Emitters

High output LED's are utilized with drive currents ranging from 175mA to 525mA. 70CRI Minimum. LED's are available in standard Neutral White (4000K), or optional Cool White (5000K) or Warm White (3000K). Consult Factory for other LED options.

Amber LED's

PCA (Phosphor Converted Amber) LED's utilize phosphors to create color output similar to LPS lamps and have a slight output in the blue spectral bandwidth. TRA (True Amber) LED's utilize material that emits light in the amber spectral bandwidth only without the use of phosphors.

Finish

Super TGIC polyester powder coating is applied onto a metal substrate this has been pretreated with a four-stage process for maximum adhesion and color retention. The top coat is baked at 400° F for maximum hardness and exterior durability.

PROJECT NAME: _____

FIXTURE TYPE: _____

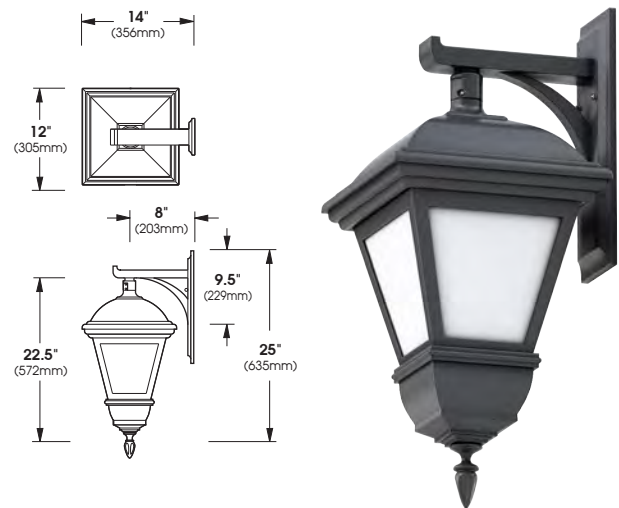
COL12-WA/XCA-UT (Post Top Mount)

COL12-WA/XCA-UP (Pendant Mount)

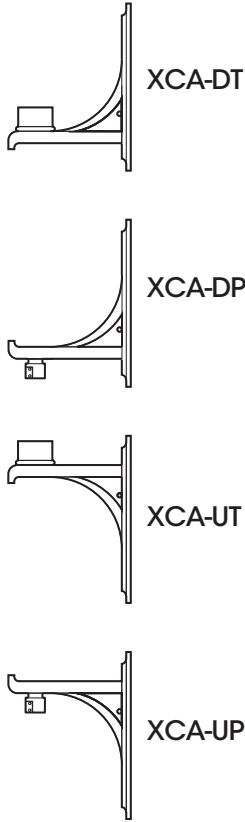
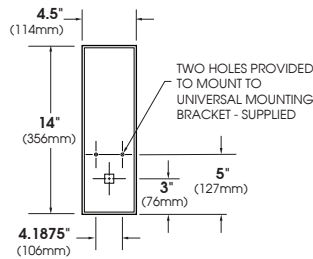

2023010

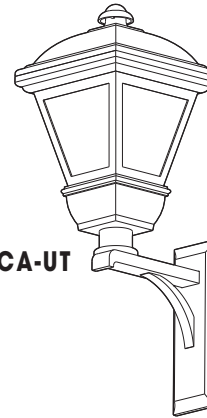
SPECIFICATIONS
MOUNTING OPTIONS

WALL PLATE

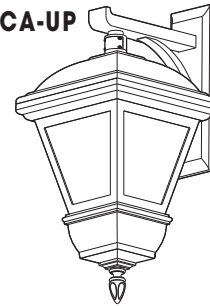

MOUNTING HARDWARE BY OTHERS.

PLED™ MODULES

COL12-WA/XCA-UT
 E.P.A. = .94
 Available in:
 20 LED Max.

20 LED MODULE

COL12-WA/XCA-UP
 E.P.A. = .82
 Available in:
 20 LED Max.

ORDERING INFORMATION

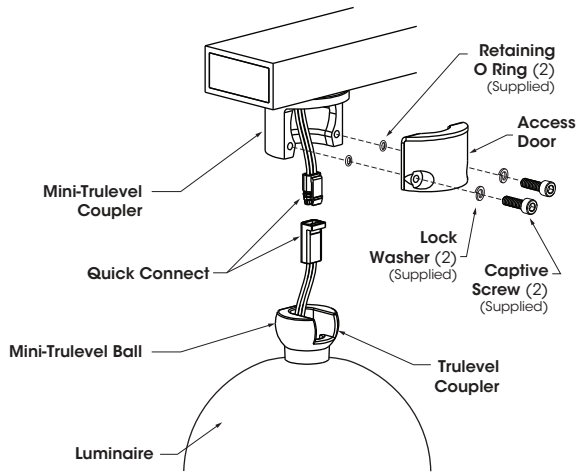
Spec/Order Example: COL12-WA/XCA-UP/PLED-III M/20LED-525mA/NW/277V/RAL-9005-T/PC+V

Luminaire & Mounting	Optics	# of LED's	Drive Current	Color	Voltage	Finish	Options
Luminaire & Mounting	Optics	LED		Color	Voltage	Finish	Options
	PLED™ Distribution Type	# of LEDs	Drive Current	Color Temp - CCT	Voltage	Standard Textured Finish	
<input type="checkbox"/> COL12-WA/XCA-DT	<input type="checkbox"/> TYPE SYMMETRIC PLED-ASY-N 	<input type="checkbox"/> 20LED	<input type="checkbox"/> 175mA	<input type="checkbox"/> NW (4000K) * STANDARD	<input type="checkbox"/> 120	<input type="checkbox"/> BLACK RAL-9005-T	<input type="checkbox"/> HOUSE SIDE SHIELDS¹ . . HS-PLED¹
<input type="checkbox"/> COL12-WA/XCA-DP			<input type="checkbox"/> 350mA	<input type="checkbox"/> CW (5000K)	<input type="checkbox"/> 208	<input type="checkbox"/> WHITE RAL-9003-T	<input type="checkbox"/> HIGH-LOW DIMMING FOR HARDWIRED SWITCHING OR NON-INTEGRATED MOTION SENSOR HLSW
<input type="checkbox"/> COL12-WA/XCA-UT	<input type="checkbox"/> TYPE SYMMETRIC PLED-ASY-W 		<input type="checkbox"/> 450mA	<input type="checkbox"/> WW (3000K)	<input type="checkbox"/> 240	<input type="checkbox"/> GREY RAL-7004-T	<input type="checkbox"/> PHOTO CELL + VOLTAGE (EXAMPLE: PC120V) . . PC+V
<input type="checkbox"/> COL12-WA/XCA-UP			<input type="checkbox"/> 525mA	OTHER LED COLORS AVAILABLE CONSULT FACTORY	<input type="checkbox"/> 277	<input type="checkbox"/> DARK BRONZE RAL-8019-T	<input type="checkbox"/> SINGLE FUSE (120V, 277V) SF
				AMBER¹	<input type="checkbox"/> 347	<input type="checkbox"/> GREEN RAL-6005-T	<input type="checkbox"/> DOUBLE FUSE (208V, 240V) DF
				<input type="checkbox"/> PHOSPHOR CONVERTED AMBER PCA	<input type="checkbox"/> 480		
				<input type="checkbox"/> TRUE AMBER TRA		For smooth finish replace suffix "T" with suffix "S" (Example: RAL-9500-S)	NOTE: ¹- HOUSESIDE SHIELDS ARE MOUNTED ON THE PLED PANEL INTERNAL TO THE CPA LENSES
				NOTES: 1- NARROW BAND AMBERS HAVE NO DEFINABLE CCT EQUIVALENT		Consult factory for custom colors	CONTACT FACTORY FOR STEP DIM MOTION SENSOR (PROGRAMMED 25-50/100)

INSTALLATION DETAIL
Mini-Trulevel System® Assembly

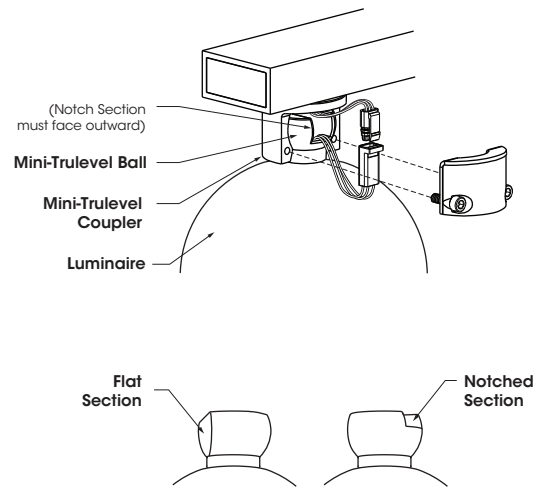
1. Loosen (2) Captive Screws and remove Access Door from Mini-Trulevel Coupler, pull out Quick Connect from Mini-Trulevel Coupler and Mini-Trulevel Ball.



2. Place Mini-Trulevel Ball inside of Mini-Trulevel Coupler as illustrated.

A - Notched Section of Mini-Trulevel Ball must face outward as illustrated.

B - Flat Section of Mini-Trulevel Ball must face inward.

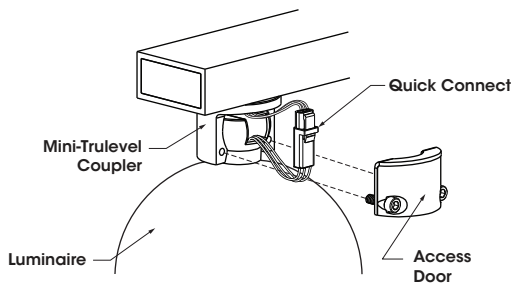

3. Connect Quick Connect components, push components inside of Mini-Trulevel Coupler cavity, replace Access Door and loosely secure, do not tighten.

Fixture will suspend without Access Door during installation.

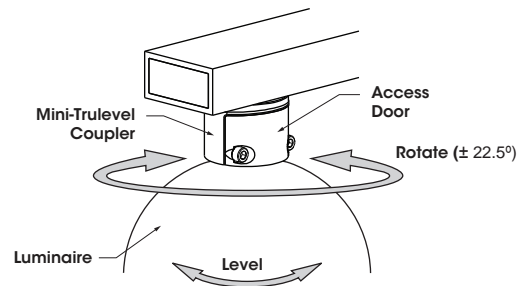

4. Rotate (left to right $\pm 22.5^\circ$) and level Luminaire to desired position. Tighten Access Door.

(Tighten each bolt to recommended torque: **10 ft-lb, foot-pound**)

Mini-Trulevel Pendant Mount is intended to allow for fixture leveling, but is not intended to be "free-swinging" upon proper installation.

ELECTRICAL GUIDE

LED COUNT	SOURCE TYPE	SOURCE	INITIAL LUMENS - 4000K	INITIAL LUMENS - 3000K	INITIAL LUMENS - 5000K	L70 GREATER THAN (HR)-TM21	STARTING TEMP.	SYSTEM WATTS	VOLTS	MAX INPUT AMPS
20	LED	20 PLED® Optical Module - 175mA	911 - 1,003	865 - 953	956 - 1,053	85,000+	-20°F	11	120 277	0.09 0.04
20	LED	20 PLED® Optical Module - 350mA	1,656 - 1,823	1,573 - 1,732	1,739 - 1,914	85,000+	-20°F	22	120 277	0.18 0.09
20	LED	20 PLED® Optical Module - 450mA	2,050 - 2,257	1,948 - 2,144	2,153 - 2,370	85,000+	-20°F	29	120 277	0.23 0.10
20	LED	20 PLED® Optical Module - 525mA	2,389 - 3,630	2,270 - 2,499	2,509 - 2,762	85,000+	-20°F	33	120 277	0.27 0.12

NOTES:

1. Max Input Amps is the highest of starting, operating, or open circuit currents
2. Lumen values for LED Modules vary according to the distribution type
3. System Watts includes the source watts and all driver components.
4. Fuse value should be sufficient to protect all wiring components. For electronic driver and LED component protection, use 10KV - 20KV surge suppressors.
5. L70(14K) - TM-21 6x rule applied

WARNING: All fixtures must be installed in accordance with local codes or the National Electrical Code. Failure to do so may result in serious personal injury.