

SOLID STATE AREA LIGHTING

DSARB SERIES-LED

FEATURES

Luminaire

Upper housing is heavy gauge cast aluminum (min. .125" wall; alloy >0.2% Cu for DSARB25) or spun aluminum with reveal (.125" min. wall for DSARB20). Lower housing is 0.080" thick spun aluminum with integrated LED module seat. Horizontal louvers (decorative bands - non-illuminated) are made of heavy gauge aluminum sheet and welded to the ballast housing. Lower housing is vented at top and bottom for convective cooling of LED module. Top Driver chamber is barriered from LED Module chamber. Trulevel ball coupling mount is welded to housing and facilitates quick leveling and installation.

LED Power Array™

Three-dimensional array of individual LED Tubes fastened to a retaining plate. Each LED Tube consists of circuit board populated with a multiple of LED's and is mechanically fastened to a radial aluminum heat sink. An acrylic lens and end cap protects the LED Tube's internal components.

Vertical Power Array™ with Refracting Lens: LED Tubes are aligned vertically and arranged radially to produce an even raw light distribution that simulates standard light sources. Used in conjunction with the external prismatic refracting which provides the optical control.

LED Emitters

High output LED's are utilized with drive currents ranging from 350mA to 525mA. 70CRI Minimum. LED's are available in standard Neutral White (4000K), or optional Cool White (5000K) or Warm White (3000K). Consult Factory for other LED options.

LED Driver

Constant current electronic with a power factor of >.90 and a minimum operating temperature of -40°F/-40°C. Driver(s) is/are UL and cUL recognized. In-line terminal blocks facilitate wiring between the driver and optical arrays. Drivers accept an input of 120-277V, 50/60Hz or 347V-480V, 50,60Hz. (0 - 10V dimmable driver is standard. Driver has a minimum of 3KV internal surge protection. Luminaire supplied with 20KV surge protector for field installation.)

Amber LED's

PCA (Phosphor Converted Amber) LED's utilize phosphors to create color output similar to LPS lamps and have a slight output in the blue spectral bandwidth. TRA (True Amber) LED's utilize material that emits light in the amber spectral bandwidth only without the use of phosphors.

Finish

Polyester powder coat incorporates four step iron phosphate process to pretreat metal surface for maximum adhesion. Top coat is baked at 400°F for maximum hardness and exterior durability.

PROJECT NAME: _____

FIXTURE TYPE: _____

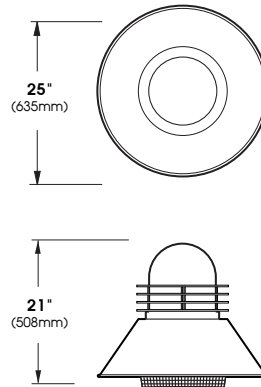

DSARB25

Patent pending

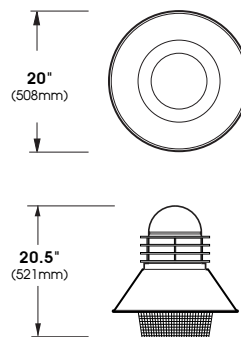

DSARB20

(Formerly DSARB1)

Patent pending

DSARB SERIES - LED

SPECIFICATIONS

Mounting Styles

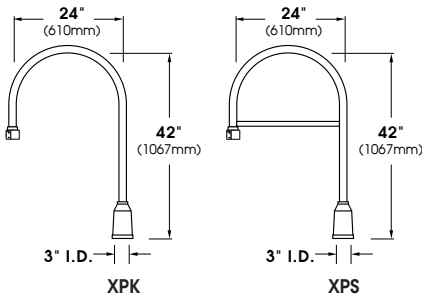
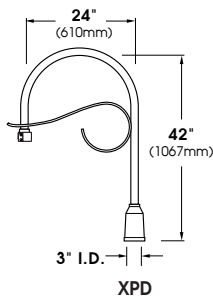

Arms are heavy wall extruded aluminum construction. For additional arm options see arm section.

Wall Mount

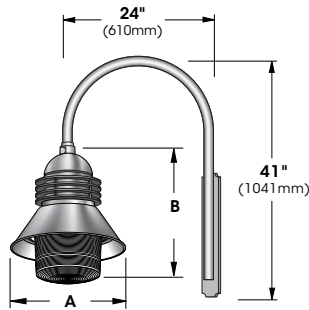

Fixture	A	B
DSARB25	25" (635mm)	21" (508mm)
DSARB20	20" (508mm)	20.5" (521mm)

Extruded and cast aluminum construction.

Wall Plate

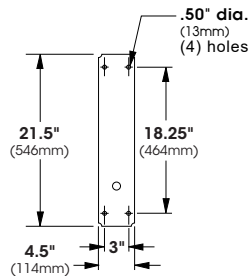

LED Power Array™ Modules

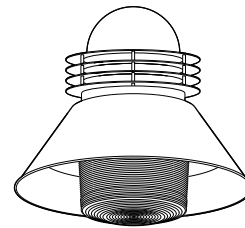

DSARB25 E.P.A. = 1.39
Available in:
80 LED Module Max

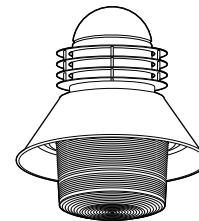
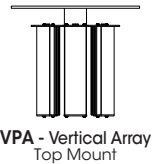

DSARB20 E.P.A. = 1.24
Available in:
48 LED Module Max

ORDERING INFORMATION

Spec/Order Example: DSARB20/VPA-SYM/24LED-350mA/NW/277/CPG/1/RAL-7005-T

Luminaire	Optics	LED Mode			Voltage	Mounting	Finish	Options
Luminaire	Optics	LED			Voltage	Mounting	Finish	Options
<input type="checkbox"/> DSARB25-LED <input type="checkbox"/> DSARB20-LED (Formerly DSARB1)	Vertical Power Array (Clear Prismatic Refracting Lens) <input type="checkbox"/> VPA-I <input type="checkbox"/> VPA-II <input type="checkbox"/> VPA-III <input type="checkbox"/> VPA-IV <input type="checkbox"/> VPA-V	# of LEDs DSARB25 <input type="checkbox"/> 80LED <input type="checkbox"/> 64LED <input type="checkbox"/> 48LED <input type="checkbox"/> 36LED DSARB20 <input type="checkbox"/> 48LED <input type="checkbox"/> 36LED <input type="checkbox"/> 20LED	Drive Current <input type="checkbox"/> 525mA <input type="checkbox"/> 350mA	Color Temp - CCT <input type="checkbox"/> NW (4000K)* *Standard <input type="checkbox"/> CW (5000K) <input type="checkbox"/> WW (3000K) Other LED Colors Available Consult Factory Amber ¹ <input type="checkbox"/> Phosphor Converted Amber PCA <input type="checkbox"/> True Amber TRA	<input type="checkbox"/> 120 <input type="checkbox"/> 208 <input type="checkbox"/> 240 <input type="checkbox"/> 277 <input type="checkbox"/> 347 <input type="checkbox"/> 480	<input type="checkbox"/> XPK <input type="checkbox"/> XPS <input type="checkbox"/> XPD <input type="checkbox"/> 1 Wallmount <input type="checkbox"/> WM	Standard Textured Finish <input type="checkbox"/> Black RAL-9005-T <input type="checkbox"/> White RAL-9003-T <input type="checkbox"/> Grey RAL-7004-T <input type="checkbox"/> Dark Bronze RAL-8019-T <input type="checkbox"/> Green RAL-6005-T For smooth finish replace suffix "T" with suffix "S" (Example: RAL-9500-S) Consult factor for custom colors	<input type="checkbox"/> Stem Mount + Length(in) (48" Max) SM+L <input type="checkbox"/> Chain Mount + Length(in) (48" Max) CM+L Internal House Side Shields <input type="checkbox"/> 90° HS90 <input type="checkbox"/> 135° HS135 <input type="checkbox"/> 180° HS180 <input type="checkbox"/> Twist Lock Receptable Only TPR <input type="checkbox"/> 7-Pin Twist Lock Receptable Only TPR7 <input type="checkbox"/> High-Low Dimming for Switch by Others/Select Levels 50/100 or 25/100 (Example: HLSW/25) HLSW <input type="checkbox"/> Photo Cell + Voltage (Example: PC120V) PC+V <input type="checkbox"/> Single Fuse (120V, 277V) SF <input type="checkbox"/> Double Fuse (208V, 240V) DF <input type="checkbox"/> Programmable Photo/Motion Sensor (Factory - Motion 50/100; Photo 75fc) MS-F311

