

SOLID STATE AREA LIGHTING

DSD SERIES-LED

FEATURES

Luminaire

Upper housing is 0.125" thick formed aluminum. Lower housing is 0.080" thick formed aluminum. Threaded receiver accepts glass diffuser. Glass diffuser is heavy wall tempered prismatic glass available in clear prismatic or prismatic opal. Pendant Mount uses Trulevel ball coupling mount. Wall mount has integrated side mount extruded aluminum arm and cast aluminum wall plate. All hardware is stainless steel.

LED Power Array™

Three-dimensional array of individual LED Tubes fastened to a retaining plate. Each LED Tube consists of circuit board populated with a multiple of LED's and is mechanically fastened to a radial aluminum heat sink. An acrylic Lens and end cap protects the LED Tube's internal components.

Vertical Power Array™: LED Tubes are aligned vertically and arranged radially to produce an even raw light distribution that simulates standard light sources. Produces a minimal glare, symmetric diffuse light distribution.

LED Emitters

High Output LED's are driven at 350mA for nominal 1 Watt output each. LED's are available in standard Neutral White (4000K), or optional Cool White (5000K) or Warm White (3000K). Consult Factory for other LED options.

LED Driver

UL and CUL recognized High Power Factor, Constant Current LED drivers operate on input voltages from 120-277VAC, 50/60hz. Consult Factory for 347-480VAC. Driver is mechanically fastened to a retaining bracket. Main power quick disconnect provided. Driver has a minimum 4KV of internal surge protection, 10KV & 20KV Surge Protector optional. Dimming and High-Low Driver options available.

Finish

Polyester powder coat incorporates four step iron phosphate process to pretreat metal surface for maximum adhesion. Top coat is baked at 400°F for maximum hardness and exterior durability.

PROJECT NAME: _____

FIXTURE TYPE: _____

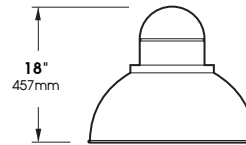
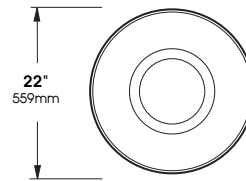

DSD22

(Formerly DSD1)

Patent pending

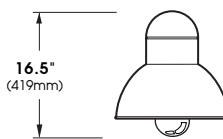

DSD14

(Formerly DSD2)

Patent pending

DSD SERIES - LED

SPECIFICATIONS

Mounting Styles

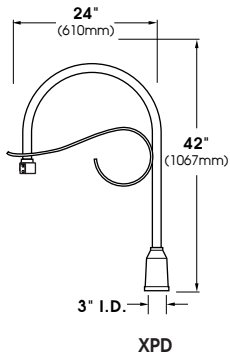

XPD

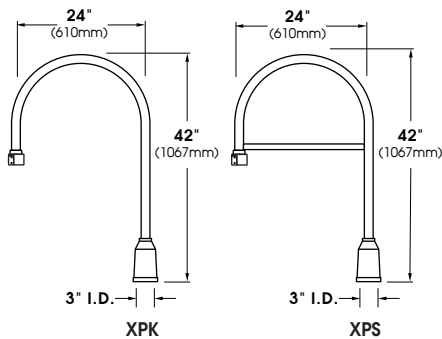

XPK

XPS

Arms are heavy wall extruded aluminum construction. For additional arm options see arm section.

Wall Mount

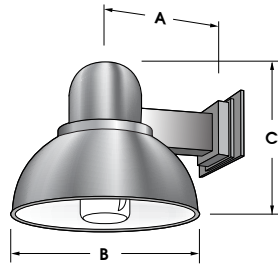

Fixture	A	B	C
DSD22	14" (356mm)	22" (559mm)	18" (457mm)
DSD14	13" (330mm)	14" (356mm)	16.5" (419mm)

Extruded aluminum arm and cast aluminum wall bracket assembly provided with built in gasketed wire access for fixture/supply wire connection.

Wall Plate

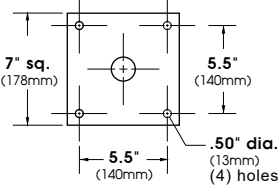

LED Power Array™ Modules

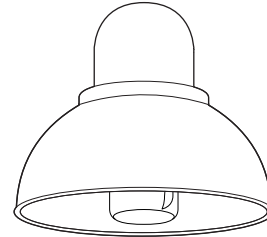

DSD22 E.P.A. = 0.97
Available in:
48 LED Module Max

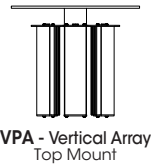



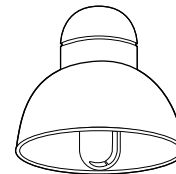



VPA - Vertical Array
Top Mount



DSD14 E.P.A. = 0.59
Available in:
36 LED Module Max

ORDERING INFORMATION

Spec/Order Example: DSD14/VPA-SYM/24LED-350mA/NW/277/CPG/1/RAL-7005-T

Luminaire	Optics	# of LEDs	Color	Voltage	Mounting	Finish	Options
Luminaire	Optics	LED			Mounting	Finish	Options
<input type="checkbox"/> DSD22-LED (Formerly DSD1)	<input type="checkbox"/> VPA - SYM 	# of LEDs	Color	Voltage	<input type="checkbox"/> XPK 	Standard Textured Finish	Lens Options
<input type="checkbox"/> DSD14-LED (Formerly DSD2)		<input type="checkbox"/> 48LED	<input type="checkbox"/> NW (4000K)* *Standard	<input type="checkbox"/> 120	<input type="checkbox"/> XPS 	<input type="checkbox"/> Black RAL-9005-T	<input type="checkbox"/> Clear Prismatic Glass Lens (Standard) CPG
		<input type="checkbox"/> 36LED	<input type="checkbox"/> CW (5000K)	<input type="checkbox"/> 208	<input type="checkbox"/> XPD 	<input type="checkbox"/> White RAL-9003-T	<input type="checkbox"/> Opal Prismatic Glass Lens WPG
		<input type="checkbox"/> 24LED	<input type="checkbox"/> WW (3000K)	<input type="checkbox"/> 240	<input type="checkbox"/> 1 	<input type="checkbox"/> Grey RAL-7004-T	<input type="checkbox"/> Stem Mount + Length(in) (48" Max) SM+L
		DSD14	Other LED Colors Available Consult Factory	<input type="checkbox"/> 277	Wallmount	<input type="checkbox"/> Dark Bronze RAL-8019-T	<input type="checkbox"/> Chain Mount + Length(in) (48" Max) CM+L
		<input type="checkbox"/> 36LED		<input type="checkbox"/> 347	<input type="checkbox"/> WM 	<input type="checkbox"/> Green RAL-6005-T	<input type="checkbox"/> Dimmable Driver(s) (0-10V) DIM
		<input type="checkbox"/> 24LED		<input type="checkbox"/> 480		For smooth finish remove suffix "T" (Example: RAL-9500)	<input type="checkbox"/> High-Low Dimming for Hardwired Switching or Non-integrated Motion Sensor HLSW
					See USALTG.COM for additional arm styles	See USALTG.COM for additional colors	<input type="checkbox"/> Photo Cell + Voltage (Example: PC120V) PC+V
							<input type="checkbox"/> 10KV Surge Protector 10SP
							<input type="checkbox"/> 20KV Surge Protector (277V & 480V Only) 20SP

