

# SOLID STATE AREA LIGHTING

## LCM SERIES-LED

### SPECIFICATIONS

#### LUMINAIRE

High Impact clear polycarbonate diffusing lenses provided with durable corrosion resistant cast aluminum housing. Top is hinged for access. Luminaire base has 3" I.D. opening for tenon. All hardware is stainless steel.

#### LED POWER ARRAY™

Three-dimensional array of individual LED Tubes fastened to a retaining plate. Each LED Tube consists of circuit board populated with a multiple of LED's and is mechanically fastened to a radial aluminum heat sink. An acrylic Lens and end cap protects the LED Tube's internal components.

**ANGLED POWER ARRAY™:** Micro-Reflectors mounted around each LED control the raw light output. LED Tubes are uniquely aimed horizontally and vertically and combined to produce highly efficient IES Distribution Types II, III, IV and V. Used in conjunction with a clear patterned diffusing lenses.

**VERTICAL POWER ARRAY™ WITH GLASS REFRACTOR:** LED Tubes are aligned vertically and arranged radially to produce an even raw light distribution that simulates standard light sources. Array is secured within a 6" Prismatic Glass Refractor which provides the optical control. Used in conjunction with clear smooth or clear patterned diffusing lenses.

**VERTICAL POWER ARRAY™:** LED Tubes are aligned vertically and arranged radially to produce an even raw light distribution that simulates standard light sources. Produces a minimal glare, symmetric diffuse light distribution. Used in conjunction with opal diffusing lenses.

#### LED EMITTERS

High Output LED's are driven at 350mA for nominal 1 Watt output each. LED's are available in standard Neutral White (4000K), or optional Cool White (5000K) or Warm White (3000K). Consult Factory for other LED options.

#### LED DRIVER

UL and CUL recognized High Power Factor, Constant Current LED drivers operate on input voltages from 120-277VAC, 50/60hz. Consult Factory for 347-480VAC. Driver is mechanically fastened to a retaining bracket. Main power quick disconnect provided. Driver has a minimum 4KV of internal surge protection, 10KV & 20KV Surge Protector optional. Dimming and High-Low Driver options available.

#### FINISH

Polyester powder coat incorporates four step iron phosphate process to pretreat metal surface for maximum adhesion. Top coat is baked at 400°F for maximum hardness and exterior durability.

PROJECT NAME: \_\_\_\_\_

PROJECT TYPE: \_\_\_\_\_



LCM

PATENT PENDING

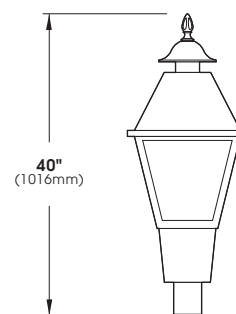

2013141

# LCM SERIES - LED

## S P E C I F I C A T I O N S

### OPTIONAL STYLES

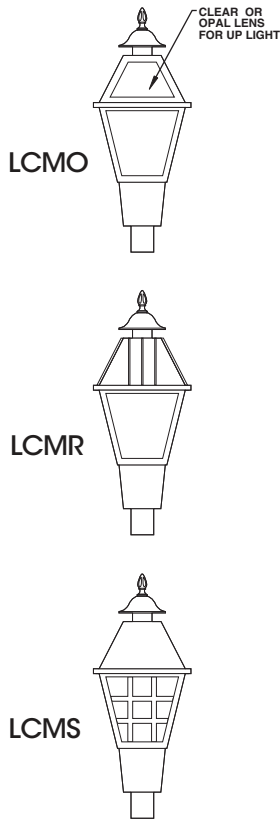

### WALL MOUNT

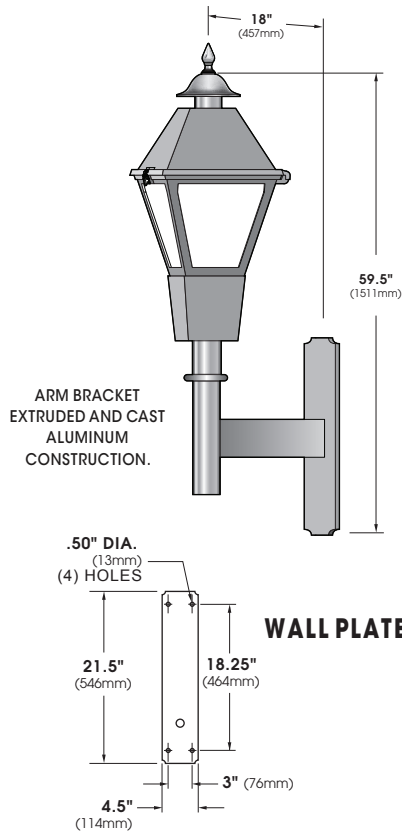

### LED POWER ARRAY™ MODULES

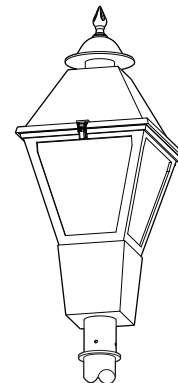

**LCM SERIES-LED**  
E.P.A. = 2.60

**ANGLED ARRAY**  
Available in:  
8 Array 48 LED Max.

**GLASS REFRACTOR w/  
VERTICAL ARRAY**  
Available in:  
6 Array 36 LED Max.

**VERTICAL ARRAY**  
Available in:  
6 Array 48 LED Max.  
8 Array 64 LED Max.

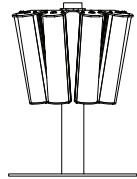

**APA - Angled Array**  
Base mount

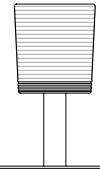

**GRV - Glass Refractor  
w/ Vertical Array**  
Base mount

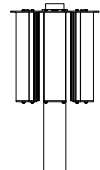

**VPA - Vertical Array**  
Base mount

(Specifications subject to change  
without prior notice.)

PATENT PENDING

## O R D E R I N G I N F O R M A T I O N

LUMINAIRE	OPTICS	# of LED's	COLOR	VOLTAGE	MOUNTING	FINISH	OPTIONS
<b>LUMINAIRE</b>	<b>OPTICS</b>	<b>LED</b>			<b>MOUNTING</b>	<b>FINISH</b>	<b>OPTIONS</b>
<b>LUMINAIRE</b>	<b>ANGLED POWER ARRAY (CLEAR PATTERNED LENS)</b>	<b>No. LEDs</b>	<b>COLOR</b>	<b>VOLTAGE</b>	<b>ARM MOUNT</b>	<b>STANDARD TEXTURED FINISH</b>	<b>LENS OPTIONS:</b>
<input type="checkbox"/> LCM-LED	<input type="checkbox"/> APA - II	<input type="checkbox"/> 48LED (53 Watts)	<input type="checkbox"/> NW (4000K)* *STANDARD	<input type="checkbox"/> 120	<input type="checkbox"/> 1	<input type="checkbox"/> BLACK RAL-9005-T	<input type="checkbox"/> CLEAR PATTERNED POLYCARBONATE ... CPP (STANDARD LENS)
<input type="checkbox"/> LCMO-LED	<input type="checkbox"/> APA - III	<input type="checkbox"/> 32LED (36 Watts)	<input type="checkbox"/> CW (5000K)	<input type="checkbox"/> 208	<input type="checkbox"/> 2-180	<input type="checkbox"/> WHITE RAL-9003-T	<input type="checkbox"/> CLEAR SMOOTH POLYCARBONATE ... CP
<input type="checkbox"/> LCMR-LED	<input type="checkbox"/> APA - IV		<input type="checkbox"/> WW (3000K)	<input type="checkbox"/> 240	<input type="checkbox"/> 2-90	<input type="checkbox"/> GREY RAL-7004-T	<input type="checkbox"/> OPAL SMOOTH ACRYLIC ... WP
<input type="checkbox"/> LCMS-LED	<input type="checkbox"/> APA - V	Wattages are Max Input Watts	OTHER LED COLORS AVAILABLE CONSULT FACTORY	<input type="checkbox"/> 277	<input type="checkbox"/> 3-90	<input type="checkbox"/> DARK BRONZE RAL-8019-T	<input type="checkbox"/> CLEAR PATTERNED ACRYLIC ... CPA
	<b>GLASS REFRACTOR (CLEAR PATTERNED OR CLEAR SMOOTH LENS)</b>	<input type="checkbox"/> 36LED (41 Watts)		<input type="checkbox"/> 480	<input type="checkbox"/> 3-120	<input type="checkbox"/> GREEN RAL-6005-T	<input type="checkbox"/> CLEAR SMOOTH ACRYLIC ... CA
	<input type="checkbox"/> GRV - III	Wattages are Max Input Watts			<input type="checkbox"/> 4-90		<input type="checkbox"/> OPAL SMOOTH POLYCARBONATE ... WA
	<input type="checkbox"/> GRV - V				<b>WALL MOUNT</b>		<input type="checkbox"/> HOUSE SIDE SHIELD ... HS
	<b>VERTICAL POWER ARRAY (OPAL LENS)</b>	<input type="checkbox"/> 64LED (72 Watts)			<input type="checkbox"/> WM	FOR SMOOTH FINISH REMOVE SUFFIX "T" (EXAMPLE: RAL-9500)	<input type="checkbox"/> DIMMABLE DRIVER(S) (0-10V) ... DIM
	<input type="checkbox"/> VPA - SYM	<input type="checkbox"/> 48LED (53 Watts)			<b>POST TOP</b>	SEE USALTG.COM FOR ADDITIONAL COLORS	<input type="checkbox"/> HIGH-LOW DIMMING FOR HARDWIRED SWITCHING OR NON-INTEGRATED MOTION SENSOR ... HLSW
		<input type="checkbox"/> 36LED (41 Watts)			<input type="checkbox"/> PT		<input type="checkbox"/> PHOTO CELL + VOLTAGE (EXAMPLE: PC120V) ... PC+V
		Wattages are Max Input Watts					<input type="checkbox"/> 10KV SURGE PROTECTOR ... 10SP
							<input type="checkbox"/> 20KV SURGE PROTECTOR (277V & 480V Only) ... 20SP