

## AREA &amp; ROADWAY LIGHTING

# Pacifica® - PLED

CONTEMPORARY, ROUND FORM POLE MOUNT LUMINAIRE

**Luminaire**

Housing and arm are heavy wall, low copper cast aluminum alloy (A356 alloy, <0.2% copper). Removable internal heatsink provides direct mounting of the LED modules and thermal control for long life and efficiency. All hardware is stainless steel. Optical access is through housing aperture. Hinged door on arm provides access to the driver and electrical compartment. Integrated mounting bolts for quick mounting to the pole. Optional heavy cast aluminum wall mounting bracket.

**PLED™ Optics**

Emitters (LED's) are arrayed on a metal core PCB panel with each emitter located on a copper thermal transfer pad and enclosed by an LED refractor. LED optics completely seal each individual emitter to meet an IP66 rating. In asymmetric distributions, a micro-reflector inside the refractor re-directs the house side emitter output towards the street side, maximizing usable light. Optional house side shields are available that cover each individual optic. Refractors are injection molded H12 acrylic. Each LED refractor is sealed to the PCB over an emitter and all refractors are retained by an aluminum frame. Any one Panel, or group of Panels in a luminaire, have the same optical pattern. LED refractors produce standard site/area distributions. Panels are field replaceable and field rotatable in 90° increments. Quick-disconnects are provided above each panel for fast field replacement. All fixture optical options will provide a "U0" no uplight optical package and is dark sky friendly.

**Ambience™ Low Luminance Lens**

Optional Ambience Lens (AL) provides low luminance reduced glare distributions. Lens diffuses the PLED Optics and provides a more uniform luminance across the aperture reducing glare at all angles. Lens is provided with an aluminum frame and is sealed to the housing with high temp gasketing.

**LED Emitters**

LED thermal management is designed to maintain LED operating temperature below 90 °C, well below the manufacturers thermal max of 150 °C for long life, high lumen maintenance and color stability. High Power White LED's are driven between 350mA and 875mA for a maximum output of 2.5 Watts nominal. LED's are available in standard Warm White (2700K & 3000K), Neutral White (4000K), or Cool White (5000K). All Standard LED's have a minimum of 70 CRI. Consult Factory for other LED options. Lumen Maintenance of L94 at 60,000 hours (TM-21 calculated at 6x Test Time).

**True Amber LED's** TRA-True Amber LED's emit light in the amber spectral bandwidth centered on 585-590nm. True Amber has negligible blue light and is suitable for wildlife.

**LED Driver**

Constant current electronic with a power factor of >.90 and a minimum operating temperature of -40°F/-40°C. Driver(s) is/are UL and cUL recognized. In-line terminal blocks facilitate wiring between the driver and optical arrays. Drivers accept an input of 120-277V, 50/60Hz or 347V-480V, 50/60Hz. 0 - 10V dimmable driver is standard. Driver has a minimum of 3KV internal surge protection. Luminaire supplied with a separate 20KV surge protector for field installation.

**Finish**

Super TGIC polyester powder coating is applied onto a metal substrate this has been pretreated with a four-stage process for maximum adhesion and color retention. The top coat is baked at 400° F for maximum hardness and exterior durability.

**PAC**

(PAC24 shown w/ Ambience™ Low Luminance Lens -AL)

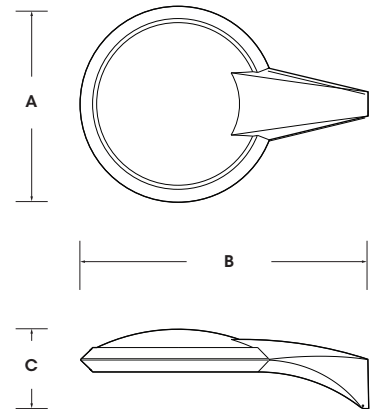

Fixture	A	B	C
PAC24	24" 610mm	36" 914mm	10" 254mm
PAC18	19" 483mm	30" 762mm	9" 229mm



2023262

**PRODUCT CONFIGURATIONS**

**EPA & WEIGHT**

No Lens

w/ Ambience™ Low Luminance Lens

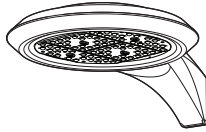

**PAC24**  
Max Weight = 58 lbs  
Max EPA = 0.87  
80 LED Max

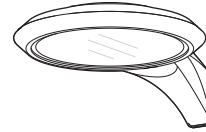

**PAC24-AL**  
Max Weight = 58 lbs  
Max EPA = 0.87  
80 LED Max

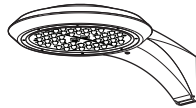

**PAC18**  
Max Weight = 30 lbs  
Max EPA = 0.60  
48 LED Max

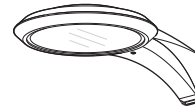

**PAC18-PT1-AL**  
Max Weight = 30 lbs  
Max EPA = 0.60  
48 LED Max

**SAMPLE ASSEMBLIES**

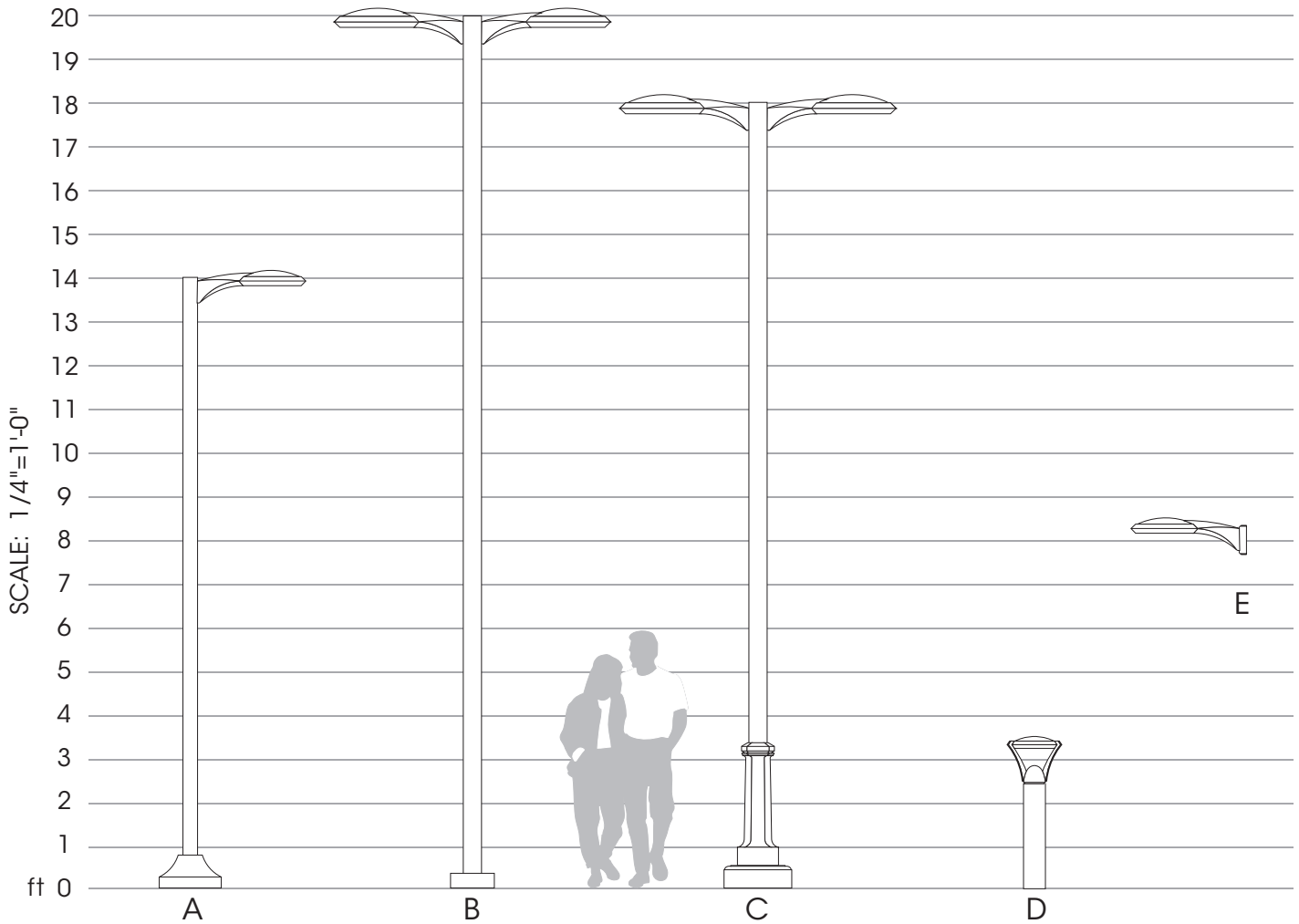

- A. RNTA-144-125-RBC/1/PAC18/LED/ACCESSORIES/FINISH
- B. RNTS205-7/2-180/PAC24-AL/LED/ACCESSORIES/FINISH
- C. 11-1050-18'-0"/2-180/PAC24/LED/ACCESSORIES/FINISH
- D. PACB/LED/ACCESSORIES/FINISH
- E. WM/PAC18-AL/LED/ACCESSORIES/FINISH

Sample Assemblies show a small offering of the Sun Valley Line of Poles, Bases, Shafts, Arms, & Luminaires. Please visit [usalgtg.com](http://usalgtg.com) for the full product offering.

**POLE DRILLING TEMPLATE**

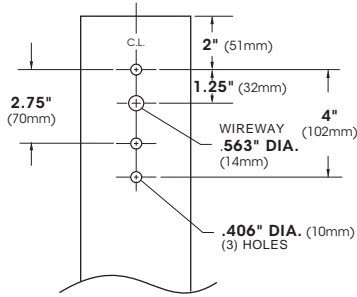

**WALL MOUNT**

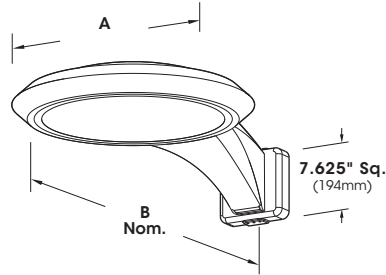

Fixture	A	B
PAC24	24" 610mm	38" 965mm
PAC18	19" 483mm	32" 813mm

Cast aluminum wall bracket assembly provided with built in gasketed wire access for fixture/supply wire connection. Mounting hardware by others.

**WALL PLATE**

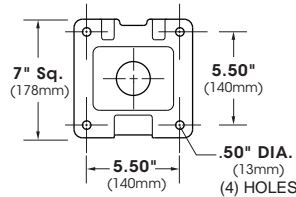

**PLED™ MODULES**

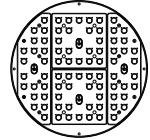

80 LED Module

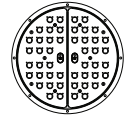

48 LED Module



36 LED Module



20 LED Module

**ORDERING INFORMATION**

Spec/Order Example: PAC24/PLED-II/80LED-875mA/27K/UNV/RAL-8019-T/DF

Luminaire	Optics	LED Mode			Voltage	Mounting	Finish	Options
Luminaire	Optics	LED			Voltage	Mounting	Finish	Options
<input type="checkbox"/> PAC24 <input type="checkbox"/> PAC18	<b>PLED™</b> Distribution Type  For NL & CPA Lens Options: <input type="checkbox"/> PLED-II <input type="checkbox"/> PLED-II-FR <input type="checkbox"/> PLED-III <input type="checkbox"/> PLED-III-W <input type="checkbox"/> PLED-IV <input type="checkbox"/> PLED-IV-FT <input type="checkbox"/> PLED-V-SQ-N <input type="checkbox"/> PLED-V-SQ-M <input type="checkbox"/> PLED-V-SQ-W  Ambience™ Lens Options <sup>4</sup> : <input type="checkbox"/> AL-ASY <input type="checkbox"/> AL-ASY-HS <input type="checkbox"/> AL-SYM	# of LEDs <input type="checkbox"/> 80LED <sup>1</sup> <input type="checkbox"/> 48LED <input type="checkbox"/> 36LED <input type="checkbox"/> 20LED <sup>2</sup>	Drive Current <input type="checkbox"/> 875mA <input type="checkbox"/> 700mA <input type="checkbox"/> 525mA <input type="checkbox"/> 350mA <input type="checkbox"/> 175mA	Color Temp - CCT <input type="checkbox"/> 27K (2700K) <input type="checkbox"/> 30K (3000K) <input type="checkbox"/> 40K (4000K) <input type="checkbox"/> 50K (5000K) <input type="checkbox"/> TRA True Amber <sup>3</sup>	<input type="checkbox"/> UNV (120-277) <input type="checkbox"/> 347 <input type="checkbox"/> 480	<b>Arm Mount</b> <input type="checkbox"/> 1 <input type="checkbox"/> 2-180 <input type="checkbox"/> 2-90 <input type="checkbox"/> 3-90 <input type="checkbox"/> 3-120 <input type="checkbox"/> 4-90  <input type="checkbox"/> Universal Pole Adaptor UPA  <b>Wall Mount</b> <input type="checkbox"/> WM  WM - Wall Mount provided with mounting bracket and cover.	<b>Standard Textured Finish</b> <input type="checkbox"/> Black RAL-9005-T <input type="checkbox"/> White RAL-9003-T <input type="checkbox"/> Grey RAL-7004-T <input type="checkbox"/> Dark Bronze RAL-8019-T <input type="checkbox"/> Green RAL-6005-T  <b>Premium Finishes</b> <input type="checkbox"/> Rust <input type="checkbox"/> Patina Copper PC  For smooth finish replace suffix "T" with suffix "S" (Example: RAL-9500-S)  Consult factory for custom colors	<input type="checkbox"/> Internal House Side Shield incl. LED Count (Example: HS-PLED/48) <b>HS-PLED</b> <input type="checkbox"/> Twist Lock Receptable Only <b>TPR</b> <input type="checkbox"/> 7-Pin Twist Lock Receptable Only <b>TPR7</b> <input type="checkbox"/> High-Low Dimming for Switch by Others/Select Levels 50/100 or 25/100 (Example: HLSW/25) <b>HLSW</b> <input type="checkbox"/> Twist Lock Photocell + Voltage (Example: TPC347V) <b>TPC+V</b> <input type="checkbox"/> Photocell + Voltage (Example: PC120V) <b>PC+V</b> <input type="checkbox"/> Single Fuse (Example: DF277V) <b>SF+V</b> <input type="checkbox"/> Double Fuse (Example: DF240V) <b>DF+V</b> <input type="checkbox"/> Blue-Tooth Programmable Photo/Motion Sensor (Factory - Motion 50/100; Photo 75c) <b>MS-F311</b>
<b>NOTES:</b> 1 - 80LED available in PAC24 only 2 - 20LED available in PAC18 only 3 - TRA available in 350mA & 525mA Drive Currents only 4 - Ambience Lens available in PAC24 (80LED) and PAC18 (48LED) only  Consult factory for other CCT, CRI, & Drive Current options								

**OPTIONS**

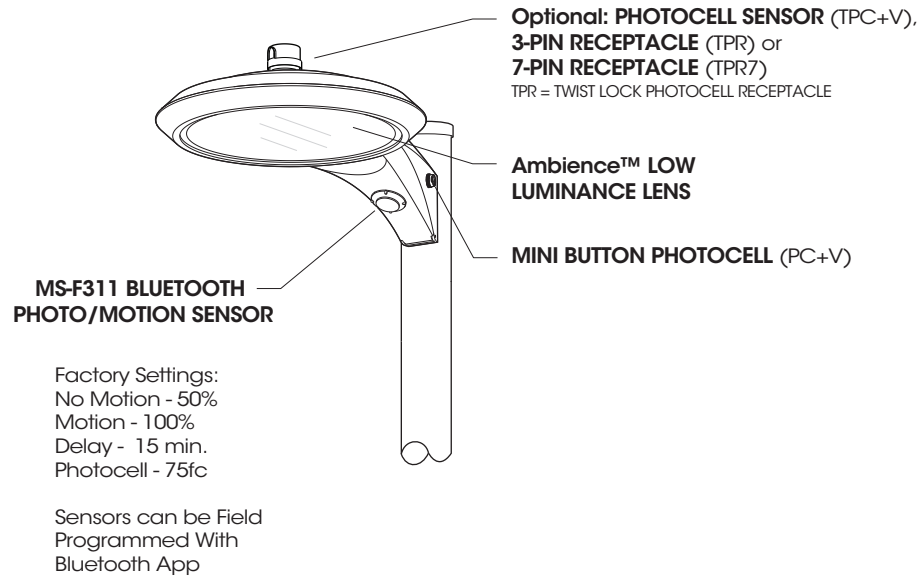

**High Low Dimming For Switches (HLSW)**

The HLSW is a small Electronic Switch which provides High Low Dimming Control through the LED Driver's 0-10V Control. Switching is done by adding a secondary AC Switched Hot Trigger Line to the HLSW in addition to the normal AC Power Line. When the Secondary Trigger Line is powered, the Fixture will go to 100% dimming. With no power to the Trigger, the Fixture will operate at 50% or 25% dimming. Switches for the Trigger Line can be a normal AC Switch/Breaker or Timed Switch/Breaker.

**Wireless and Other Fixture Controls**

Contact factory for Wireless and other Fixture Controls and recommendations. Most Controls can be integrated and factory Installed.

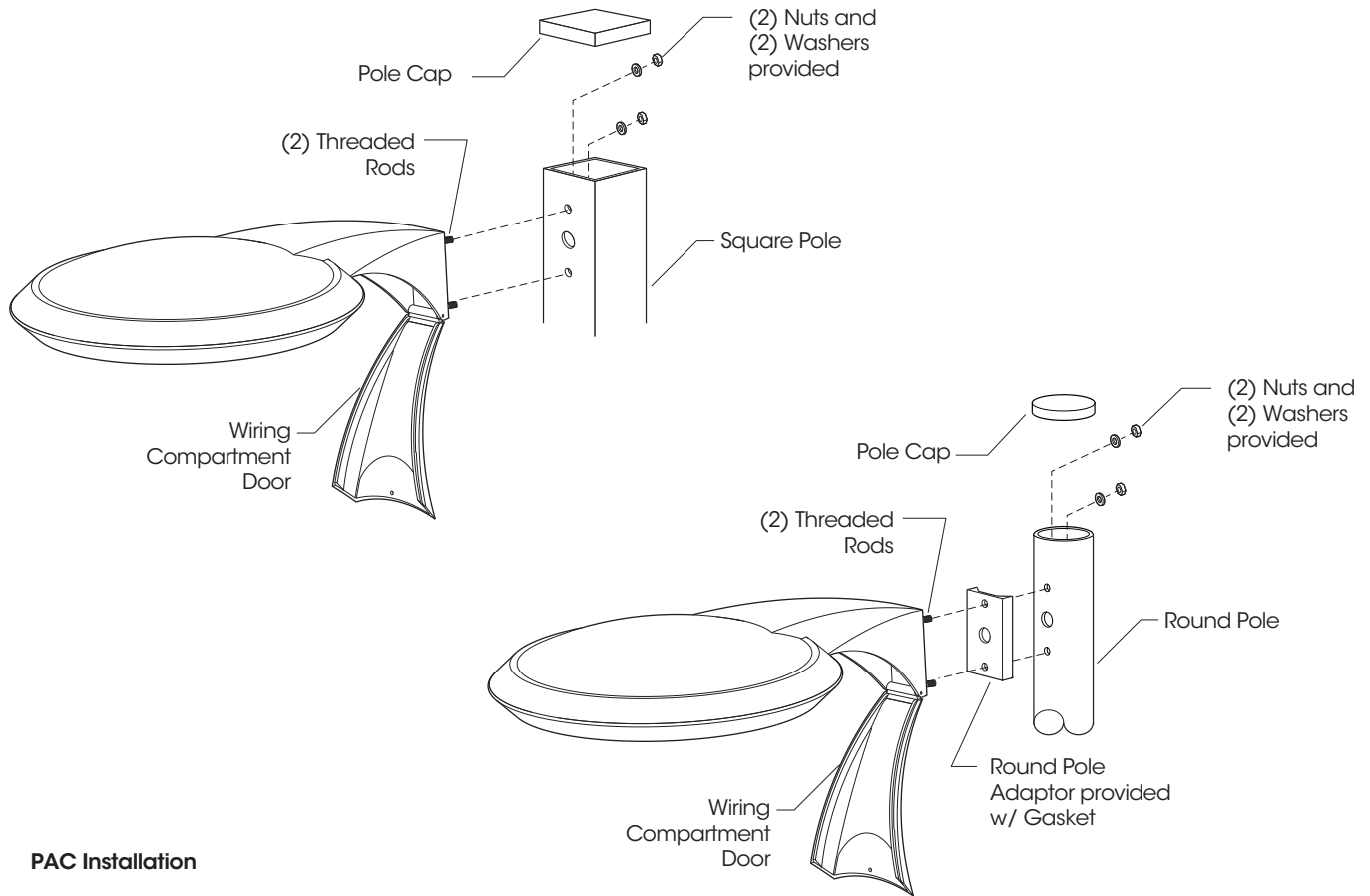

**PAC Installation**

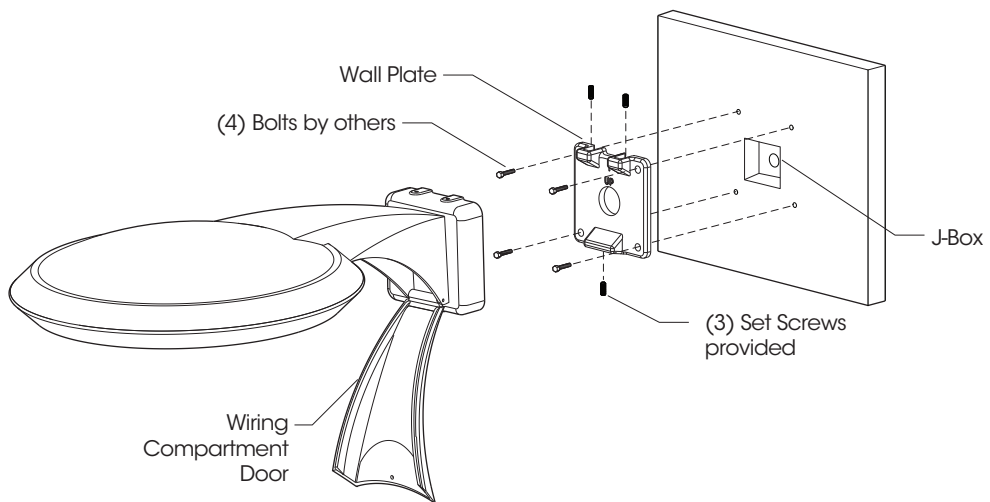

**PAC-WM Installation**

## PHOTOMETRIC DATA GUIDE - LM-80 LUMEN MAINTENANCE

LED LUMEN MAINTENANCE (350mA to 875mA)		
LED Life / Operating Hours	Lumen Depreciation	Lumen Depreciation Scale Factor
60,000	L96	0.96x
100,000 (6X LED Test Hrs)	L93	0.93x
150,000 (Theoretical)	L89	0.90x
200,000 (Theoretical)	L86	0.87x

TM-21 6x Test Time Dicates that L93 > 100,000 Hours.

Lumen Depreciation Calculations Done in Accordance With IESNA TM-21 & LM-80 (25°C Ambient)

## ELECTRICAL DATA GUIDE - AMPERAGE CHART

# of LEDs	mA	System Watts	120V	208V	277V	347V	480V
20	350	23.6	0.20	0.11	0.09	0.07	0.05
20	525	35.5	0.30	0.17	0.13	0.10	0.07
20	700	47.0	0.39	0.23	0.17	0.14	0.10
20	875	58.4	0.49	0.28	0.21	0.17	0.12
36	350	41.3	0.34	0.20	0.15	0.12	0.09
36	525	62.0	0.52	0.30	0.22	0.18	0.13
36	700	82.6	0.69	0.40	0.30	0.24	0.17
36	875	103.1	0.86	0.50	0.37	0.30	0.21
48	175	26.5	0.22	0.13	0.10	0.08	0.06
48	350	53.6	0.45	0.26	0.19	0.15	0.11
48	525	80.7	0.67	0.39	0.29	0.23	0.17
48	700	108.0	0.90	0.52	0.39	0.31	0.23
48	875	134.7	1.12	0.65	0.49	0.39	0.28
80	175	41.9	0.35	0.20	0.15	0.12	0.09
80	350	85.8	0.72	0.41	0.31	0.25	0.18
80	525	129.7	1.08	0.62	0.47	0.37	0.27
80	700	173.5	1.45	0.83	0.63	0.50	0.36
80	875	221.5	1.85	1.06	0.80	0.64	0.46

**PHOTOMETRIC DATA GUIDE - ISOFOOTCANDLE PLOTS**

PAC18-PLED-36LED-700mA-40K - 16 Mounting Height (14' Pole)

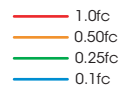
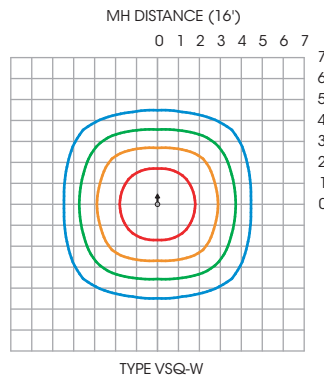
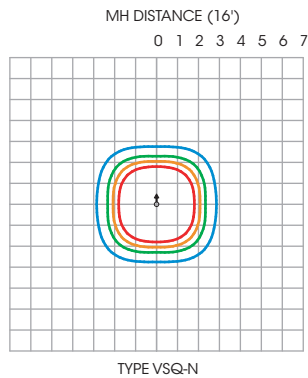
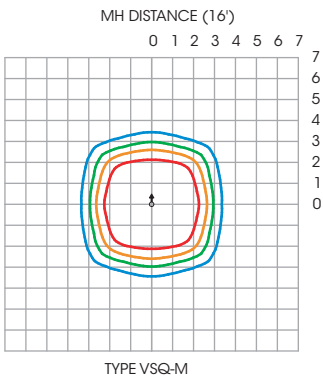
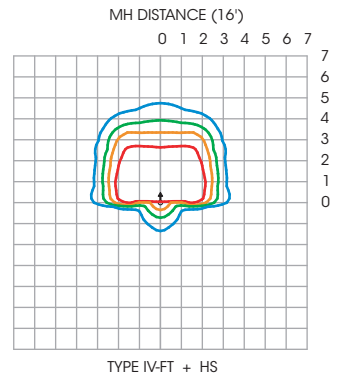
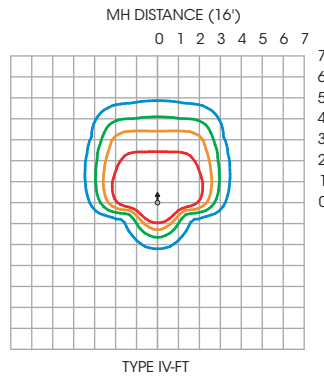
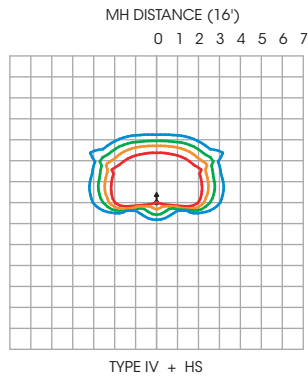
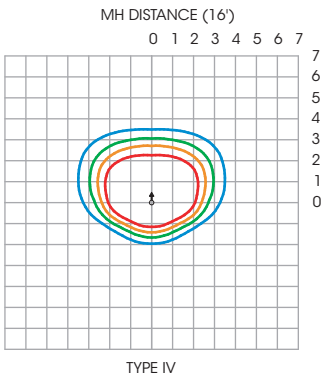
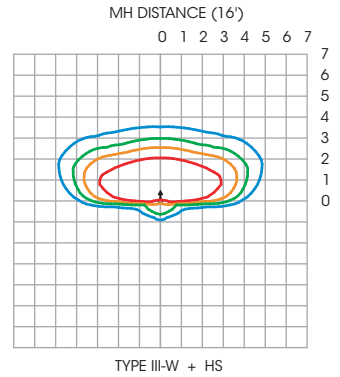
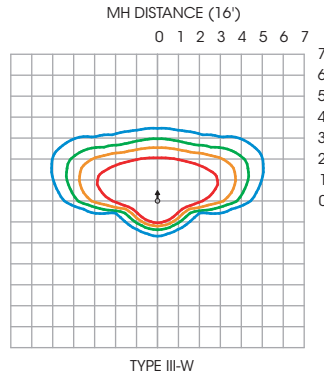
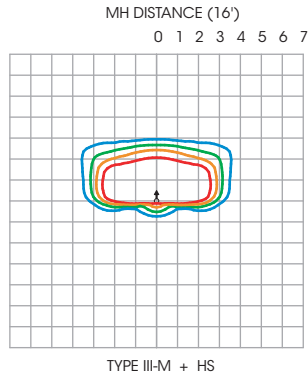
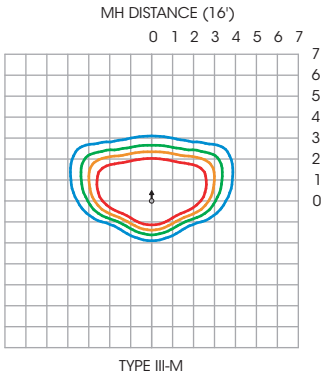
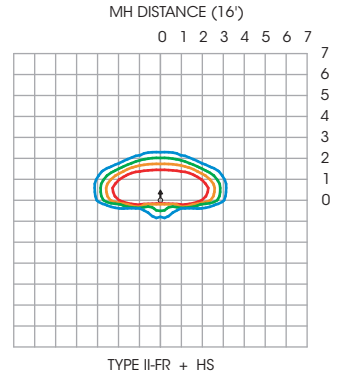
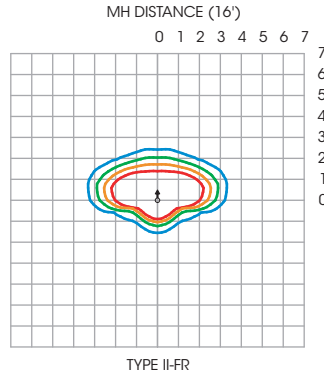
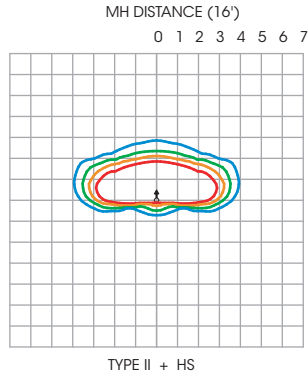
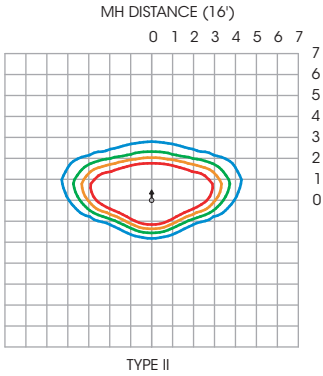



## PHOTOMETRIC DATA GUIDE - LUMEN TABLES (PAC-PLED)

PAC18-PLED																								
LED Count	Drive Current (mA)	System Watts	Dist'n Type	27K (2700K - 70CRI)			30K (3000K - 70CRI)			40K (4000K - 70CRI)			50K (5000K - 70CRI)			System Watts	TRA (590nm)							
				LUMENS	LPW	BUG RATING	LUMENS	LPW	BUG RATING	LUMENS	LPW	BUG RATING	LUMENS	LPW	BUG RATING		LUMENS	LPW	BUG RATING					
20	350	23.6	II	3152	134	B1-U0-G1	3288	139	B1-U0-G1	3426	145	B1-U0-G1	3563	151	B1-U0-G1	18.2	1096	60	B0-U0-G0					
			II-FR	3173	134	B1-U0-G1	3311	140	B1-U0-G1	3449	146	B1-U0-G1	3587	152	B1-U0-G1		1104	61	B0-U0-G0					
			III-M	3207	136	B1-U0-G1	3346	142	B1-U0-G1	3486	148	B1-U0-G1	3625	154	B1-U0-G1		1115	61	B0-U0-G0					
			III-W	2978	126	B1-U0-G1	3107	132	B1-U0-G1	3237	137	B1-U0-G1	3366	143	B1-U0-G1		1036	57	B0-U0-G1					
			IV	3183	135	B1-U0-G1	3321	141	B1-U0-G1	3459	147	B1-U0-G1	3598	152	B1-U0-G1		1107	61	B0-U0-G0					
			IV-FT	2899	123	B1-U0-G1	3025	128	B1-U0-G1	3151	134	B1-U0-G1	3277	139	B1-U0-G1		1008	55	B0-U0-G1					
			VSQ-N	3327	141	B2-U0-G0	3472	147	B2-U0-G0	3616	153	B2-U0-G0	3761	159	B2-U0-G0		1157	64	B1-U0-G0					
			VSQ-M	3262	138	B2-U0-G1	3404	144	B2-U0-G1	3546	150	B2-U0-G1	3688	156	B2-U0-G1		1135	62	B1-U0-G0					
			VSQ-W	3184	135	B2-U0-G1	3322	141	B2-U0-G1	3461	147	B3-U0-G1	3600	153	B3-U0-G1		1108	61	B1-U0-G1					
			II-HS	2305	98	B0-U0-G1	2405	102	B0-U0-G1	2505	106	B0-U0-G1	2606	110	B0-U0-G1		802	44	B0-U0-G0					
			II-FR-HS	2345	99	B0-U0-G0	2447	104	B0-U0-G0	2549	108	B0-U0-G0	2651	112	B0-U0-G0		816	45	B0-U0-G0					
			III-M-HS	2332	99	B0-U0-G1	2433	103	B0-U0-G1	2535	107	B0-U0-G1	2636	112	B0-U0-G1		811	45	B0-U0-G0					
			III-W-HS	2282	97	B0-U0-G1	2382	101	B0-U0-G1	2481	105	B0-U0-G1	2580	109	B0-U0-G1		794	44	B0-U0-G1					
			IV-HS	2409	102	B0-U0-G1	2513	106	B0-U0-G1	2618	111	B0-U0-G1	2722	115	B0-U0-G1		838	46	B0-U0-G0					
			IV-FT-HS	2277	96	B0-U0-G1	2376	101	B0-U0-G1	2475	105	B0-U0-G1	2574	109	B0-U0-G1		792	44	B0-U0-G1					
			20	525	35.5	II	4481	126	B1-U0-G1	4676	132	B1-U0-G1	4871	137	B1-U0-G1		5066	143	B1-U0-G1	27.3	1266	46	B1-U0-G0	
						II-FR	4511	127	B1-U0-G1	4707	133	B1-U0-G1	4904	138	B1-U0-G1		5100	144	B1-U0-G1		1275	47	B1-U0-G0	
						III-M	4560	128	B1-U0-G1	4758	134	B1-U0-G1	4956	140	B1-U0-G1		5154	145	B1-U0-G1		1288	47	B0-U0-G0	
III-W	4234	119				B1-U0-G2	4418	124	B1-U0-G2	4602	130	B1-U0-G2	4786	135	B1-U0-G2	1196	44	B0-U0-G1						
IV	4525	127				B1-U0-G1	4722	133	B1-U0-G1	4919	139	B1-U0-G1	5116	144	B1-U0-G1	1279	47	B0-U0-G1						
IV-FT	4123	116				B1-U0-G2	4302	121	B1-U0-G2	4481	126	B1-U0-G2	4660	131	B1-U0-G2	1165	43	B0-U0-G1						
VSQ-N	4730	133				B2-U0-G1	4935	139	B2-U0-G1	5141	145	B2-U0-G1	5347	151	B2-U0-G1	1337	49	B1-U0-G0						
VSQ-M	4638	131				B3-U0-G1	4839	136	B3-U0-G1	5041	142	B3-U0-G1	5243	148	B3-U0-G1	1311	48	B1-U0-G0						
VSQ-W	4528	128				B3-U0-G2	4725	133	B3-U0-G2	4921	139	B3-U0-G2	5118	144	B3-U0-G2	1279	47	B1-U0-G1						
II-HS	3278	92				B0-U0-G1	3420	96	B0-U0-G1	3563	100	B0-U0-G1	3705	104	B0-U0-G1	926	34	B0-U0-G0						
II-FR-HS	3334	94				B0-U0-G1	3479	98	B0-U0-G1	3624	102	B0-U0-G1	3768	106	B0-U0-G1	942	35	B0-U0-G0						
III-M-HS	3316	93				B0-U0-G1	3460	97	B0-U0-G1	3604	102	B0-U0-G1	3748	106	B0-U0-G1	937	34	B0-U0-G0						
III-W-HS	3246	91				B0-U0-G1	3387	95	B0-U0-G1	3528	99	B0-U0-G1	3669	103	B0-U0-G2	917	34	B0-U0-G1						
IV-HS	3425	96				B0-U0-G1	3574	101	B0-U0-G1	3722	105	B0-U0-G1	3871	109	B0-U0-G1	968	35	B0-U0-G0						
IV-FT-HS	3237	91				B0-U0-G2	3377	95	B0-U0-G2	3518	99	B0-U0-G2	3659	103	B0-U0-G2	915	34	B0-U0-G1						
20	700	47.0				II	5637	120	B1-U0-G1	5882	125	B2-U0-G1	6127	130	B2-U0-G1	6372	136	B2-U0-G2	N/A		N/A			
						II-FR	5674	121	B2-U0-G1	5921	126	B2-U0-G1	6168	131	B2-U0-G1	6414	136	B2-U0-G1						
						III-M	5735	122	B1-U0-G2	5984	127	B1-U0-G2	6234	133	B2-U0-G2	6483	138	B2-U0-G2						
			III-W	5325	113	B1-U0-G2	5556	118	B1-U0-G2	5788	123	B1-U0-G2	6019	128	B1-U0-G2									
			IV	5692	121	B1-U0-G1	5939	126	B1-U0-G2	6187	132	B2-U0-G2	6435	137	B2-U0-G2									
			IV-FT	5185	110	B1-U0-G2	5410	115	B1-U0-G2	5636	120	B1-U0-G2	5861	125	B1-U0-G2									
			VSQ-N	5949	127	B2-U0-G1	6208	132	B2-U0-G1	6466	138	B2-U0-G1	6725	143	B2-U0-G1									
			VSQ-M	5834	124	B3-U0-G1	6088	130	B3-U0-G1	6341	135	B3-U0-G1	6595	140	B3-U0-G1									
			VSQ-W	5694	121	B3-U0-G2	5942	126	B3-U0-G2	6189	132	B3-U0-G2	6437	137	B3-U0-G2									
			II-HS	4122	88	B0-U0-G1	4302	92	B0-U0-G1	4481	95	B0-U0-G1	4660	99	B1-U0-G1									
			II-FR-HS	4193	89	B0-U0-G1	4376	93	B0-U0-G1	4558	97	B0-U0-G1	4740	101	B0-U0-G1									
			III-M-HS	4170	89	B0-U0-G1	4351	93	B0-U0-G2	4533	96	B0-U0-G2	4714	100	B0-U0-G2									
			III-W-HS	4082	87	B0-U0-G2	4259	91	B0-U0-G2	4437	94	B0-U0-G2	4614	98	B0-U0-G2									
			IV-HS	4308	92	B0-U0-G1	4495	96	B0-U0-G1	4682	100	B0-U0-G2	4869	104	B0-U0-G2									
			IV-FT-HS	4071	87	B0-U0-G2	4248	90	B0-U0-G2	4425	94	B0-U0-G2	4602	98	B0-U0-G2									
			20	875	58.4	II	6639	114	B2-U0-G2	6928	119	B2-U0-G2	7216	124	B2-U0-G2	7505	129	B2-U0-G2		N/A			N/A	
						II-FR	6683	114	B2-U0-G1	6974	119	B2-U0-G1	7264	124	B2-U0-G1	7555	129	B2-U0-G1						
						III-M	6755	116	B2-U0-G2	7048	121	B2-U0-G2	7342	126	B2-U0-G2	7636	131	B2-U0-G2						
III-W	6272	107				B1-U0-G2	6545	112	B1-U0-G2	6817	117	B1-U0-G2	7090	121	B1-U0-G2									
IV	6704	115				B2-U0-G2	6996	120	B2-U0-G2	7287	125	B2-U0-G2	7579	130	B2-U0-G2									
IV-FT	6107	105				B1-U0-G2	6373	109	B1-U0-G2	6638	114	B1-U0-G2	6904	118	B1-U0-G2									
VSQ-N	7007	120				B2-U0-G1	7312	125	B2-U0-G1	7617	130	B2-U0-G1	7921	136	B3-U0-G1									
VSQ-M	6871	118				B3-U0-G1	7170	123	B3-U0-G1	7469	128	B3-U0-G1	7767	133	B3-U0-G2									
VSQ-W	6707	115				B3-U0-G2	6999	120	B3-U0-G2	7290	125	B3-U0-G2	7582	130	B3-U0-G2									
II-HS	4855	83				B1-U0-G2	5066	87	B1-U0-G2	5278	90	B1-U0-G2	5489	94	B1-U0-G2									
II-FR-HS	4939	85				B0-U0-G1	5154	88	B0-U0-G1	5368	92	B0-U0-G1	5583	96	B0-U0-G1									
III-M-HS	4912	84				B0-U0-G2	5126	88	B0-U0-G2	5339	91	B0-U0-G2	5553	95	B0-U0-G2									
III-W-HS	4808	82				B0-U0-G2	5017	86	B0-U0-G2	5226	89	B0-U0-G2	5436	93	B0-U0-G2									
IV-HS	5074	87				B0-U0-G2	5295	91	B0-U0-G2	5515	94	B0-U0-G2	5735	98	B0-U0-G2									
IV-FT-HS	4795	82				B0-U0-G2	5003	86	B0-U0-G2	5212	89	B0-U0-G2	5420	93	B0-U0-G2									

IES File downloads for this product can be found at [www.usalgt.com/downloads/asr.html](http://www.usalgt.com/downloads/asr.html)

## PHOTOMETRIC DATA GUIDE - LUMEN TABLES (PAC-PLED)

PAC18-PLED																								
LED Count	Drive Current (mA)	System Watts	Dist'n Type	27K (2700K - 70CRI)			30K (3000K - 70CRI)			40K (4000K - 70CRI)			50K (5000K - 70CRI)			System Watts	TRA (590nm)							
				LUMENS	LPW	BUG RATING	LUMENS	LPW	BUG RATING	LUMENS	LPW	BUG RATING	LUMENS	LPW	BUG RATING		LUMENS	LPW	BUG RATING					
36	350	41.3	II	5529	134	B1-U0-G1	5769	140	B2-U0-G1	6010	146	B2-U0-G1	6250	151	B2-U0-G1	31.8	1923	60	B1-U0-G1					
			II-FR	5567	135	B1-U0-G1	5809	141	B2-U0-G1	6051	147	B2-U0-G1	6293	152	B2-U0-G1		1936	61	B1-U0-G0					
			III-M	5626	136	B1-U0-G1	5871	142	B1-U0-G2	6115	148	B1-U0-G2	6360	154	B2-U0-G2		1957	62	B1-U0-G1					
			III-W	5224	126	B1-U0-G2	5451	132	B1-U0-G2	5678	137	B1-U0-G2	5905	143	B1-U0-G2		1817	57	B1-U0-G1					
			IV	5584	135	B1-U0-G1	5826	141	B1-U0-G1	6069	147	B2-U0-G2	6312	153	B2-U0-G2		1942	61	B1-U0-G1					
			IV-FT	5086	123	B1-U0-G2	5307	129	B1-U0-G2	5529	134	B1-U0-G2	5750	139	B1-U0-G2		1769	56	B1-U0-G1					
			VSQ-N	5837	141	B2-U0-G1	6091	147	B2-U0-G1	6344	154	B2-U0-G1	6598	160	B2-U0-G1		2030	64	B1-U0-G0					
			VSQ-M	5723	139	B3-U0-G1	5972	145	B3-U0-G1	6221	151	B3-U0-G1	6469	157	B3-U0-G1		1991	63	B1-U0-G0					
			VSQ-W	5586	135	B3-U0-G2	5829	141	B3-U0-G2	6072	147	B3-U0-G2	6315	153	B3-U0-G2		1943	61	B2-U0-G1					
			II-HS	4044	98	B0-U0-G1	4220	102	B0-U0-G1	4395	106	B0-U0-G1	4571	111	B1-U0-G1		1407	44	B0-U0-G0					
			II-FR-HS	4114	100	B0-U0-G1	4293	104	B0-U0-G1	4471	108	B0-U0-G1	4650	113	B0-U0-G1		1431	45	B0-U0-G0					
			III-M-HS	4091	99	B0-U0-G1	4269	103	B0-U0-G2	4447	108	B0-U0-G2	4624	112	B0-U0-G2		1423	45	B0-U0-G0					
			III-W-HS	4005	97	B0-U0-G2	4178	101	B0-U0-G2	4353	105	B0-U0-G2	4527	110	B0-U0-G2		1393	44	B0-U0-G1					
			IV-HS	4225	102	B0-U0-G1	4409	107	B0-U0-G1	4592	111	B0-U0-G1	4776	116	B0-U0-G2		1470	46	B0-U0-G0					
			IV-FT-HS	3994	97	B0-U0-G2	4167	101	B0-U0-G2	4341	105	B0-U0-G2	4515	109	B0-U0-G2		1389	44	B0-U0-G1					
			36	525	62.0	II	7862	127	B2-U0-G2	8204	132	B2-U0-G2	8545	138	B2-U0-G2		8887	143	B2-U0-G2	47.7	2222	47	B1-U0-G1	
						II-FR	7915	128	B2-U0-G1	8259	133	B2-U0-G1	8603	139	B2-U0-G1		8947	144	B2-U0-G1		2237	47	B1-U0-G0	
						III-M	7999	129	B2-U0-G2	8347	135	B2-U0-G2	8695	140	B2-U0-G2		9043	146	B2-U0-G2		2261	47	B1-U0-G1	
III-W	7428	120				B1-U0-G2	7751	125	B1-U0-G2	8074	130	B2-U0-G2	8397	135	B2-U0-G2	2099	44	B1-U0-G1						
IV	7939	128				B2-U0-G2	8284	134	B2-U0-G2	8630	139	B2-U0-G2	8975	145	B2-U0-G2	2244	47	B1-U0-G1						
IV-FT	7232	117				B2-U0-G2	7547	122	B2-U0-G2	7861	127	B2-U0-G2	8176	132	B2-U0-G2	2044	43	B1-U0-G1						
VSQ-N	8297	134				B3-U0-G1	8658	140	B3-U0-G1	9019	145	B3-U0-G1	9380	151	B3-U0-G1	2345	49	B1-U0-G0						
VSQ-M	8137	131				B3-U0-G2	8491	137	B3-U0-G2	8844	143	B3-U0-G2	9198	148	B3-U0-G2	2299	48	B2-U0-G1						
VSQ-W	7943	128				B3-U0-G2	8289	134	B3-U0-G2	8634	139	B4-U0-G2	8980	145	B4-U0-G2	2245	47	B2-U0-G1						
II-HS	5750	93				B1-U0-G2	6000	97	B1-U0-G2	6250	101	B1-U0-G2	6500	105	B1-U0-G2	1625	34	B0-U0-G0						
II-FR-HS	5849	94				B1-U0-G1	6103	98	B1-U0-G1	6357	103	B1-U0-G1	6611	107	B1-U0-G1	1653	35	B0-U0-G0						
III-M-HS	5817	94				B0-U0-G2	6069	98	B0-U0-G2	6322	102	B0-U0-G2	6575	106	B0-U0-G2	1644	34	B0-U0-G1						
III-W-HS	5694	92				B0-U0-G2	5941	96	B0-U0-G2	6189	100	B0-U0-G2	6436	104	B0-U0-G2	1609	34	B0-U0-G1						
IV-HS	6008	97				B0-U0-G2	6269	101	B0-U0-G2	6530	105	B0-U0-G2	6791	110	B0-U0-G2	1698	36	B0-U0-G1						
IV-FT-HS	5678	92				B0-U0-G2	5925	96	B0-U0-G2	6172	100	B0-U0-G2	6419	104	B0-U0-G2	1605	34	B0-U0-G1						
36	700	82.6				II	9889	120	B2-U0-G2	10319	125	B2-U0-G2	10749	130	B2-U0-G2	11179	135	B2-U0-G2	N/A		N/A			
						II-FR	9955	121	B2-U0-G1	10388	126	B2-U0-G1	10820	131	B2-U0-G1	11253	136	B3-U0-G1						
						III-M	10061	122	B2-U0-G2	10499	127	B2-U0-G2	10936	132	B2-U0-G2	11374	138	B2-U0-G2						
			III-W	9342	113	B2-U0-G3	9748	118	B2-U0-G3	10154	123	B2-U0-G3	10560	128	B2-U0-G3									
			IV	9986	121	B2-U0-G2	10420	126	B2-U0-G2	10854	131	B2-U0-G2	11289	137	B2-U0-G2									
			IV-FT	9096	110	B2-U0-G3	9492	115	B2-U0-G3	9887	120	B2-U0-G3	10283	124	B2-U0-G3									
			VSQ-N	10437	126	B3-U0-G1	10890	132	B3-U0-G1	11344	137	B3-U0-G1	11798	143	B3-U0-G1									
			VSQ-M	10235	124	B3-U0-G2	10680	129	B4-U0-G2	11125	135	B4-U0-G2	11570	140	B4-U0-G2									
			VSQ-W	9990	121	B4-U0-G3	10425	126	B4-U0-G3	10859	131	B4-U0-G3	11294	137	B4-U0-G3									
			II-HS	7232	88	B1-U0-G2	7547	91	B1-U0-G2	7861	95	B1-U0-G2	8175	99	B1-U0-G2									
			II-FR-HS	7356	89	B1-U0-G1	7676	93	B1-U0-G1	7996	97	B1-U0-G1	8315	101	B1-U0-G1									
			III-M-HS	7316	89	B0-U0-G2	7634	92	B1-U0-G2	7952	96	B1-U0-G2	8270	100	B1-U0-G2									
			III-W-HS	7161	87	B0-U0-G2	7472	90	B0-U0-G2	7784	94	B0-U0-G2	8095	98	B1-U0-G2									
			IV-HS	7557	91	B1-U0-G2	7886	95	B1-U0-G2	8214	99	B1-U0-G2	8542	103	B1-U0-G2									
			IV-FT-HS	7142	86	B1-U0-G3	7453	90	B1-U0-G3	7763	94	B1-U0-G3	8074	98	B1-U0-G3									
			36	875	103.1	II	11647	113	B2-U0-G2	12154	118	B2-U0-G2	12660	123	B2-U0-G2	13166	128	B2-U0-G2		N/A		N/A		
						II-FR	11725	114	B3-U0-G1	12235	119	B3-U0-G1	12744	124	B3-U0-G1	13254	129	B3-U0-G1						
						III-M	11851	115	B2-U0-G2	12366	120	B2-U0-G2	12881	125	B2-U0-G2	13396	130	B2-U0-G2						
III-W	11003	107				B2-U0-G3	11482	111	B2-U0-G3	11960	116	B2-U0-G3	12438	121	B2-U0-G3									
IV	11762	114				B2-U0-G2	12273	119	B2-U0-G2	12784	124	B2-U0-G2	13296	129	B2-U0-G2									
IV-FT	10715	104				B2-U0-G3	11180	108	B2-U0-G3	11646	113	B2-U0-G3	12112	117	B2-U0-G3									
VSQ-N	12294	119				B3-U0-G1	12828	124	B3-U0-G1	13363	130	B3-U0-G1	13897	135	B3-U0-G1									
VSQ-M	12054	117				B4-U0-G2	12578	122	B4-U0-G2	13102	127	B4-U0-G2	13627	132	B4-U0-G2									
VSQ-W	11767	114				B4-U0-G3	12278	119	B4-U0-G3	12790	124	B4-U0-G3	13302	129	B4-U0-G3									
II-HS	8518	83				B1-U0-G2	8889	86	B1-U0-G2	9259	90	B1-U0-G2	9629	93	B1-U0-G2									
II-FR-HS	8665	84				B1-U0-G1	9042	88	B1-U0-G1	9418	91	B1-U0-G1	9795	95	B1-U0-G1									
III-M-HS	8618	84				B1-U0-G2	8992	87	B1-U0-G2	9367	91	B1-U0-G2	9741	94	B1-U0-G2									
III-W-HS	8436	82				B1-U0-G2	8802	85	B1-U0-G2	9169	89	B1-U0-G2	9536	92	B1-U0-G3									
IV-HS	8901	86				B1-U0-G2	9288	90	B1-U0-G2	9675	94	B1-U0-G2	10062	98	B1-U0-G2									
IV-FT-HS	8413	82				B1-U0-G3	8778	85	B1-U0-G3	9144	89	B1-U0-G3	9510	92	B1-U0-G3									

IES File downloads for this product can be found at [www.usalgt.com/downloads/asr.html](http://www.usalgt.com/downloads/asr.html)

## PHOTOMETRIC DATA GUIDE - LUMEN TABLES (PAC-PLED)

PAC18-PLED																										
LED Count	Drive Current (mA)	System Watts	Dist'n Type	27K (2700K - 70CRI)			30K (3000K - 70CRI)			40K (4000K - 70CRI)			50K (5000K - 70CRI)			System Watts	TRA (590nm)									
				LUMENS	LPW	BUG RATING	LUMENS	LPW	BUG RATING	LUMENS	LPW	BUG RATING	LUMENS	LPW	BUG RATING		LUMENS	LPW	BUG RATING							
48	350	53.6	II	7280	136	B2-U0-G2	7596	142	B2-U0-G2	7913	148	B2-U0-G2	8229	154	B2-U0-G2	41.3	2532	61	B1-U0-G1							
			II-FR	7329	137	B2-U0-G1	7648	143	B2-U0-G1	7967	149	B2-U0-G1	8285	155	B2-U0-G1		2549	62	B1-U0-G1							
			III-M	7407	138	B2-U0-G2	7729	144	B2-U0-G2	8052	150	B2-U0-G2	8374	156	B2-U0-G2		2577	62	B1-U0-G1							
			III-W	6878	128	B1-U0-G2	7177	134	B1-U0-G2	7476	139	B1-U0-G2	7775	145	B1-U0-G2		2392	58	B1-U0-G1							
			IV	7351	137	B2-U0-G2	7671	143	B2-U0-G2	7991	149	B2-U0-G2	8310	155	B2-U0-G2		2557	62	B1-U0-G1							
			IV-FT	6697	125	B1-U0-G2	6988	130	B1-U0-G2	7279	136	B2-U0-G2	7570	141	B2-U0-G2		2329	56	B1-U0-G1							
			VSQ-N	7685	143	B2-U0-G1	8019	150	B3-U0-G1	8353	156	B3-U0-G1	8687	162	B3-U0-G1		2673	65	B1-U0-G0							
			VSQ-M	7534	141	B3-U0-G1	7862	147	B3-U0-G2	8190	153	B3-U0-G2	8517	159	B3-U0-G2		2621	63	B2-U0-G1							
			VSQ-W	7355	137	B3-U0-G2	7674	143	B3-U0-G2	7994	149	B3-U0-G2	8314	155	B3-U0-G2		2558	62	B2-U0-G1							
			II-HS	5324	99	B1-U0-G2	5556	104	B1-U0-G2	5787	108	B1-U0-G2	6019	112	B1-U0-G2		1852	45	B0-U0-G1							
			II-FR-HS	5416	101	B0-U0-G1	5652	105	B1-U0-G1	5887	110	B1-U0-G1	6123	114	B1-U0-G1		1884	46	B0-U0-G0							
			III-M-HS	5386	100	B0-U0-G2	5620	105	B0-U0-G2	5854	109	B0-U0-G2	6089	114	B0-U0-G2		1873	45	B0-U0-G1							
			III-W-HS	5272	98	B0-U0-G2	5501	103	B0-U0-G2	5731	107	B0-U0-G2	5960	111	B0-U0-G2		1834	44	B0-U0-G1							
			IV-HS	5563	104	B0-U0-G2	5805	108	B0-U0-G2	6047	113	B0-U0-G2	6288	117	B0-U0-G2		1935	47	B0-U0-G1							
			IV-FT-HS	5258	98	B0-U0-G2	5487	102	B0-U0-G2	5715	107	B0-U0-G2	5944	111	B0-U0-G2		1829	44	B0-U0-G1							
			48	525	80.7	II	10351	128	B2-U0-G2	10801	134	B2-U0-G2	11251	139	B2-U0-G2		11701	145	B2-U0-G2	62.1	2925	47	B1-U0-G1			
						II-FR	10420	129	B2-U0-G1	10873	135	B2-U0-G1	11326	140	B3-U0-G1		11779	146	B3-U0-G1		2945	47	B1-U0-G1			
						III-M	10532	131	B2-U0-G2	10990	136	B2-U0-G2	11448	142	B2-U0-G2		11906	148	B2-U0-G2		2976	48	B1-U0-G1			
III-W	9780	121				B2-U0-G3	10205	126	B2-U0-G3	10630	132	B2-U0-G3	11055	137	B2-U0-G3	2764	45	B1-U0-G1								
IV	10453	130				B2-U0-G2	10907	135	B2-U0-G2	11362	141	B2-U0-G2	11816	146	B2-U0-G2	2954	48	B1-U0-G1								
IV-FT	9522	118				B2-U0-G3	9936	123	B2-U0-G3	10350	128	B2-U0-G3	10764	133	B2-U0-G3	2691	43	B1-U0-G1								
VSQ-N	10925	135				B3-U0-G1	11400	141	B3-U0-G1	11875	147	B3-U0-G1	12350	153	B3-U0-G1	3088	50	B1-U0-G0								
VSQ-M	10713	133				B4-U0-G2	11178	139	B4-U0-G2	11644	144	B4-U0-G2	12110	150	B4-U0-G2	3027	49	B2-U0-G1								
VSQ-W	10459	130				B4-U0-G3	10913	135	B4-U0-G3	11368	141	B4-U0-G3	11823	147	B4-U0-G3	2955	48	B2-U0-G1								
II-HS	7570	94				B1-U0-G2	7900	98	B1-U0-G2	8229	102	B1-U0-G2	8558	106	B1-U0-G2	2139	34	B0-U0-G1								
II-FR-HS	7700	95				B1-U0-G1	8035	100	B1-U0-G1	8370	104	B1-U0-G1	8705	108	B1-U0-G1	2176	35	B0-U0-G0								
III-M-HS	7658	95				B1-U0-G2	7991	99	B1-U0-G2	8324	103	B1-U0-G2	8657	107	B1-U0-G2	2164	35	B0-U0-G1								
III-W-HS	7496	93				B0-U0-G2	7822	97	B0-U0-G2	8148	101	B1-U0-G2	8474	105	B1-U0-G2	2118	34	B0-U0-G1								
IV-HS	7910	98				B1-U0-G2	8254	102	B1-U0-G2	8598	107	B1-U0-G2	8942	111	B1-U0-G2	2235	36	B0-U0-G1								
IV-FT-HS	7476	93				B1-U0-G3	7801	97	B1-U0-G3	8126	101	B1-U0-G3	8451	105	B1-U0-G3	2113	34	B0-U0-G1								
48	700	108.0				II	13020	121	B2-U0-G2	13586	126	B2-U0-G2	14152	131	B2-U0-G2	14718	136	B3-U0-G2	N/A		N/A					
						II-FR	13106	121	B3-U0-G1	13676	127	B3-U0-G1	14246	132	B3-U0-G1	14816	137	B3-U0-G2								
						III-M	13247	123	B2-U0-G2	13823	128	B2-U0-G2	14399	133	B2-U0-G2	14975	139	B2-U0-G2								
			III-W	12299	114	B2-U0-G3	12834	119	B2-U0-G3	13369	124	B2-U0-G3	13903	129	B2-U0-G3											
			IV	13147	122	B2-U0-G2	13719	127	B2-U0-G2	14291	132	B2-U0-G2	14862	138	B2-U0-G2											
			IV-FT	11976	111	B2-U0-G3	12497	116	B2-U0-G3	13017	121	B2-U0-G3	13538	125	B2-U0-G3											
			VSQ-N	13741	127	B3-U0-G1	14338	133	B3-U0-G1	14936	138	B3-U0-G1	15533	144	B3-U0-G1											
			VSQ-M	13475	125	B4-U0-G2	14061	130	B4-U0-G2	14647	136	B4-U0-G2	15233	141	B4-U0-G2											
			VSQ-W	13153	122	B4-U0-G3	13725	127	B4-U0-G3	14297	132	B4-U0-G3	14869	138	B4-U0-G3											
			II-HS	9522	88	B1-U0-G2	9936	92	B1-U0-G2	10350	96	B1-U0-G2	10763	100	B1-U0-G2											
			II-FR-HS	9685	90	B1-U0-G1	10106	94	B1-U0-G1	10527	97	B1-U0-G1	10948	101	B1-U0-G1											
			III-M-HS	9632	89	B1-U0-G2	10051	93	B1-U0-G2	10469	97	B1-U0-G2	10888	101	B1-U0-G2											
			III-W-HS	9428	87	B1-U0-G3	9838	91	B1-U0-G3	10248	95	B1-U0-G3	10658	99	B1-U0-G3											
			IV-HS	9950	92	B1-U0-G2	10382	96	B1-U0-G2	10815	100	B1-U0-G2	11247	104	B1-U0-G2											
			IV-FT-HS	9403	87	B1-U0-G3	9812	91	B1-U0-G3	10221	95	B1-U0-G3	10630	98	B1-U0-G3											
			48	875	134.7	II	15335	114	B3-U0-G2	16001	119	B3-U0-G3	16668	124	B3-U0-G3	17335	129	B3-U0-G3		N/A				N/A		
						II-FR	15437	115	B3-U0-G2	16108	120	B3-U0-G2	16779	125	B3-U0-G2	17450	130	B3-U0-G2								
						III-M	15602	116	B3-U0-G2	16281	121	B3-U0-G3	16959	126	B3-U0-G3	17637	131	B3-U0-G3								
III-W	14487	108				B2-U0-G3	15117	112	B2-U0-G3	15746	117	B3-U0-G3	16376	122	B3-U0-G3											
IV	15485	115				B3-U0-G2	16159	120	B3-U0-G2	16832	125	B3-U0-G3	17505	130	B3-U0-G3											
IV-FT	14107	105				B2-U0-G3	14720	109	B3-U0-G3	15333	114	B3-U0-G3	15947	118	B3-U0-G3											
VSQ-N	16186	120				B4-U0-G1	16889	125	B4-U0-G2	17593	131	B4-U0-G2	18297	136	B4-U0-G2											
VSQ-M	15871	118				B4-U0-G2	16561	123	B4-U0-G2	17251	128	B4-U0-G2	17941	133	B4-U0-G2											
VSQ-W	15492	115				B4-U0-G3	16166	120	B4-U0-G3	16839	125	B4-U0-G3	17513	130	B5-U0-G3											
II-HS	11215	83				B1-U0-G2	11703	87	B1-U0-G2	12190	90	B1-U0-G2	12678	94	B1-U0-G2											
II-FR-HS	11408	85				B1-U0-G2	11904	88	B1-U0-G2	12400	92	B1-U0-G2	12896	96	B1-U0-G2											
III-M-HS	11346	84				B1-U0-G2	11839	88	B1-U0-G3	12332	92	B1-U0-G3	12826	95	B1-U0-G3											
III-W-HS	11106	82				B1-U0-G3	11589	86	B1-U0-G3	12072	90	B1-U0-G3	12555	93	B1-U0-G3											
IV-HS	11719	87				B1-U0-G2	12229	91	B1-U0-G2	12738	95	B1-U0-G2	13248	98	B1-U0-G3											
IV-FT-HS	11076	82				B1-U0-G3	11557	86	B1-U0-G3	12039	89	B1-U0-G3	12521	93	B1-U0-G3											

IES File downloads for this product can be found at [www.usalgt.com/downloads/asr.html](http://www.usalgt.com/downloads/asr.html)

**PHOTOMETRIC DATA GUIDE - ISOFOOTCANDLE PLOTS**

PAC24-PLED-80LED-525mA-40K - 20' Mounting Height (18' Pole)

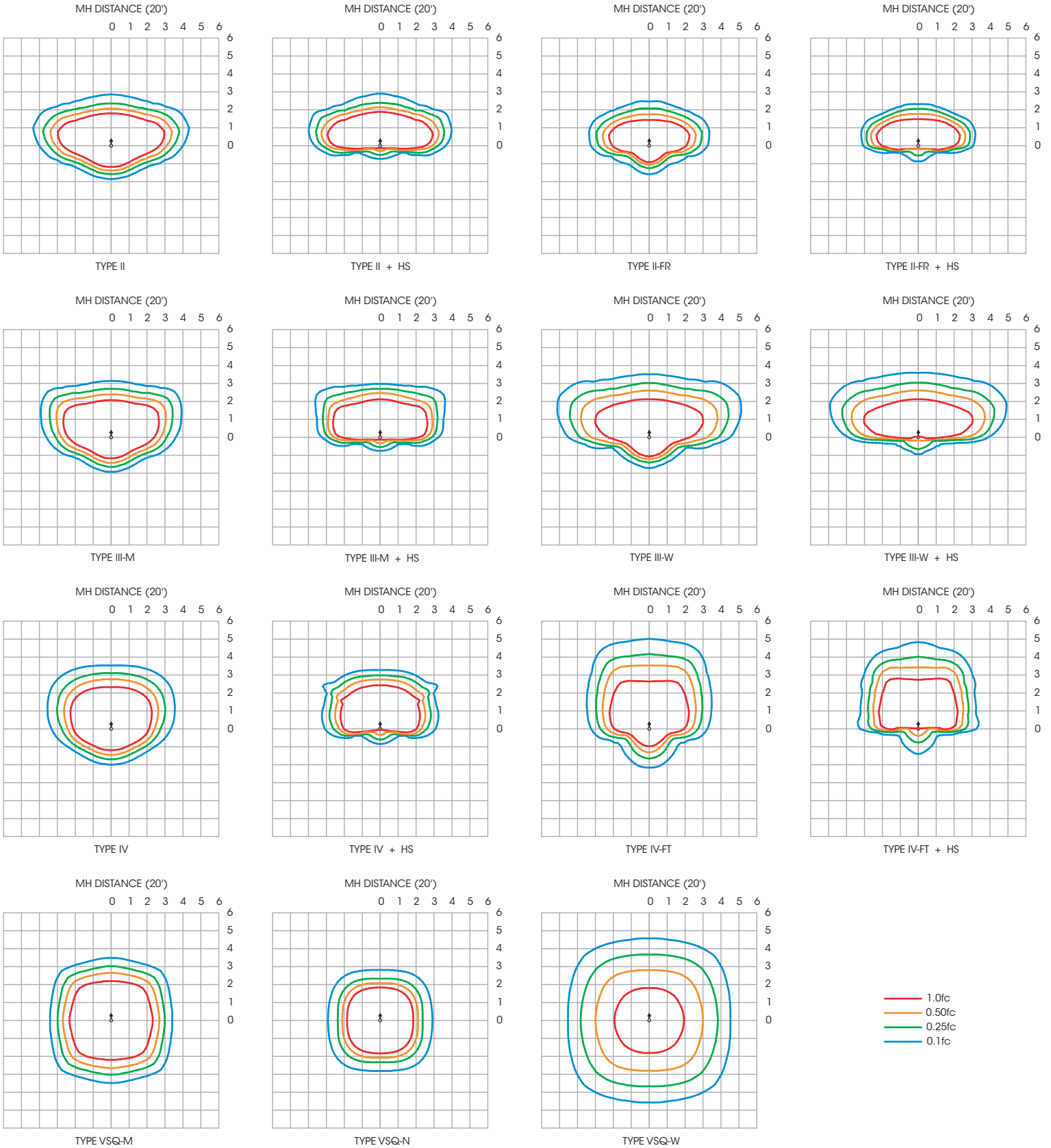

## PHOTOMETRIC DATA GUIDE - LUMEN TABLES (PAC-PLED)

PAC24-PLED																										
LED Count	Drive Current (mA)	System Watts	Dist'n Type	27K (2700K - 70CRI)			30K (3000K - 70CRI)			40K (4000K - 70CRI)			50K (5000K - 70CRI)			System Watts	TRA (590nm)									
				LUMENS	LPW	BUG RATING	LUMENS	LPW	BUG RATING	LUMENS	LPW	BUG RATING	LUMENS	LPW	BUG RATING		LUMENS	LPW	BUG RATING							
36	350	41.3	II	5529	134	B1-U0-G1	5769	140	B2-U0-G1	6010	146	B2-U0-G1	6250	151	B2-U0-G1	31.8	1923	60	B1-U0-G1							
			II-FR	5567	135	B1-U0-G1	5809	141	B2-U0-G1	6051	147	B2-U0-G1	6293	152	B2-U0-G1		1936	61	B1-U0-G0							
			III-M	5626	136	B1-U0-G1	5871	142	B1-U0-G2	6115	148	B1-U0-G2	6360	154	B2-U0-G2		1957	62	B1-U0-G1							
			III-W	5224	126	B1-U0-G2	5451	132	B1-U0-G2	5678	137	B1-U0-G2	5905	143	B1-U0-G2		1817	57	B1-U0-G1							
			IV	5584	135	B1-U0-G1	5826	141	B1-U0-G1	6069	147	B2-U0-G2	6312	153	B2-U0-G2		1942	61	B1-U0-G1							
			IV-FT	5086	123	B1-U0-G2	5307	129	B1-U0-G2	5529	134	B1-U0-G2	5750	139	B1-U0-G2		1769	56	B1-U0-G1							
			VSQ-N	5837	141	B2-U0-G1	6091	147	B2-U0-G1	6344	154	B2-U0-G1	6598	160	B2-U0-G1		2030	64	B1-U0-G0							
			VSQ-M	5723	139	B3-U0-G1	5972	145	B3-U0-G1	6221	151	B3-U0-G1	6469	157	B3-U0-G1		1991	63	B1-U0-G0							
			VSQ-W	5586	135	B3-U0-G2	5829	141	B3-U0-G2	6072	147	B3-U0-G2	6315	153	B3-U0-G2		1943	61	B2-U0-G1							
			II-HS	4044	98	B0-U0-G1	4220	102	B0-U0-G1	4395	106	B0-U0-G1	4571	111	B1-U0-G1		1407	44	B0-U0-G0							
			II-FR-HS	4114	100	B0-U0-G1	4293	104	B0-U0-G1	4471	108	B0-U0-G1	4650	113	B0-U0-G1		1431	45	B0-U0-G0							
			III-M-HS	4091	99	B0-U0-G1	4269	103	B0-U0-G2	4447	108	B0-U0-G2	4624	112	B0-U0-G2		1423	45	B0-U0-G0							
			III-W-HS	4005	97	B0-U0-G2	4178	101	B0-U0-G2	4353	105	B0-U0-G2	4527	110	B0-U0-G2		1393	44	B0-U0-G1							
			IV-HS	4225	102	B0-U0-G1	4409	107	B0-U0-G1	4592	111	B0-U0-G1	4776	116	B0-U0-G2		1470	46	B0-U0-G0							
			IV-FT-HS	3994	97	B0-U0-G2	4167	101	B0-U0-G2	4341	105	B0-U0-G2	4515	109	B0-U0-G2		1389	44	B0-U0-G1							
			36	525	62.0	II	7862	127	B2-U0-G2	8204	132	B2-U0-G2	8545	138	B2-U0-G2		8887	143	B2-U0-G2	47.7	2222	47	B1-U0-G1			
						II-FR	7915	128	B2-U0-G1	8259	133	B2-U0-G1	8603	139	B2-U0-G1		8947	144	B2-U0-G1		2237	47	B1-U0-G0			
						III-M	7999	129	B2-U0-G2	8347	135	B2-U0-G2	8695	140	B2-U0-G2		9043	146	B2-U0-G2		2261	47	B1-U0-G1			
III-W	7428	120				B1-U0-G2	7751	125	B1-U0-G2	8074	130	B2-U0-G2	8397	135	B2-U0-G2	2099	44	B1-U0-G1								
IV	7939	128				B2-U0-G2	8284	134	B2-U0-G2	8630	139	B2-U0-G2	8975	145	B2-U0-G2	2244	47	B1-U0-G1								
IV-FT	7232	117				B2-U0-G2	7547	122	B2-U0-G2	7861	127	B2-U0-G2	8176	132	B2-U0-G2	2044	43	B1-U0-G1								
VSQ-N	8297	134				B3-U0-G1	8658	140	B3-U0-G1	9019	145	B3-U0-G1	9380	151	B3-U0-G1	2345	49	B1-U0-G0								
VSQ-M	8137	131				B3-U0-G2	8491	137	B3-U0-G2	8844	143	B3-U0-G2	9198	148	B3-U0-G2	2299	48	B2-U0-G1								
VSQ-W	7943	128				B3-U0-G2	8289	134	B3-U0-G2	8634	139	B4-U0-G2	8980	145	B4-U0-G2	2245	47	B2-U0-G1								
II-HS	5750	93				B1-U0-G2	6000	97	B1-U0-G2	6250	101	B1-U0-G2	6500	105	B1-U0-G2	1625	34	B0-U0-G0								
II-FR-HS	5849	94				B1-U0-G1	6103	98	B1-U0-G1	6357	103	B1-U0-G1	6611	107	B1-U0-G1	1653	35	B0-U0-G0								
III-M-HS	5817	94				B0-U0-G2	6069	98	B0-U0-G2	6322	102	B0-U0-G2	6575	106	B0-U0-G2	1644	34	B0-U0-G1								
III-W-HS	5694	92				B0-U0-G2	5941	96	B0-U0-G2	6189	100	B0-U0-G2	6436	104	B0-U0-G2	1609	34	B0-U0-G1								
IV-HS	6008	97				B0-U0-G2	6269	101	B0-U0-G2	6530	105	B0-U0-G2	6791	110	B0-U0-G2	1698	36	B0-U0-G1								
IV-FT-HS	5678	92				B0-U0-G2	5925	96	B0-U0-G2	6172	100	B0-U0-G2	6419	104	B0-U0-G2	1605	34	B0-U0-G1								
36	700	82.6				II	9889	120	B2-U0-G2	10319	125	B2-U0-G2	10749	130	B2-U0-G2	11179	135	B2-U0-G2	N/A		N/A					
						II-FR	9955	121	B2-U0-G1	10388	126	B2-U0-G1	10820	131	B2-U0-G1	11253	136	B3-U0-G1								
						III-M	10061	122	B2-U0-G2	10499	127	B2-U0-G2	10936	132	B2-U0-G2	11374	138	B2-U0-G2								
			III-W	9342	113	B2-U0-G3	9748	118	B2-U0-G3	10154	123	B2-U0-G3	10560	128	B2-U0-G3											
			IV	9986	121	B2-U0-G2	10420	126	B2-U0-G2	10854	131	B2-U0-G2	11289	137	B2-U0-G2											
			IV-FT	9096	110	B2-U0-G3	9492	115	B2-U0-G3	9887	120	B2-U0-G3	10283	124	B2-U0-G3											
			VSQ-N	10437	126	B3-U0-G1	10890	132	B3-U0-G1	11344	137	B3-U0-G1	11798	143	B3-U0-G1											
			VSQ-M	10235	124	B3-U0-G2	10680	129	B4-U0-G2	11125	135	B4-U0-G2	11570	140	B4-U0-G2											
			VSQ-W	9990	121	B4-U0-G3	10425	126	B4-U0-G3	10859	131	B4-U0-G3	11294	137	B4-U0-G3											
			II-HS	7232	88	B1-U0-G2	7547	91	B1-U0-G2	7861	95	B1-U0-G2	8175	99	B1-U0-G2											
			II-FR-HS	7356	89	B1-U0-G1	7676	93	B1-U0-G1	7996	97	B1-U0-G1	8315	101	B1-U0-G1											
			III-M-HS	7316	89	B0-U0-G2	7634	92	B1-U0-G2	7952	96	B1-U0-G2	8270	100	B1-U0-G2											
			III-W-HS	7161	87	B0-U0-G2	7472	90	B0-U0-G2	7784	94	B0-U0-G2	8095	98	B1-U0-G2											
			IV-HS	7557	91	B1-U0-G2	7886	95	B1-U0-G2	8214	99	B1-U0-G2	8542	103	B1-U0-G2											
			IV-FT-HS	7142	86	B1-U0-G3	7453	90	B1-U0-G3	7763	94	B1-U0-G3	8074	98	B1-U0-G3											
			36	875	103.1	II	11647	113	B2-U0-G2	12154	118	B2-U0-G2	12660	123	B2-U0-G2	13166	128	B2-U0-G2		N/A				N/A		
						II-FR	11725	114	B3-U0-G1	12235	119	B3-U0-G1	12744	124	B3-U0-G1	13254	129	B3-U0-G1								
						III-M	11851	115	B2-U0-G2	12366	120	B2-U0-G2	12881	125	B2-U0-G2	13396	130	B2-U0-G2								
III-W	11003	107				B2-U0-G3	11482	111	B2-U0-G3	11960	116	B2-U0-G3	12438	121	B2-U0-G3											
IV	11762	114				B2-U0-G2	12273	119	B2-U0-G2	12784	124	B2-U0-G2	13296	129	B2-U0-G2											
IV-FT	10715	104				B2-U0-G3	11180	108	B2-U0-G3	11646	113	B2-U0-G3	12112	117	B2-U0-G3											
VSQ-N	12294	119				B3-U0-G1	12828	124	B3-U0-G1	13363	130	B3-U0-G1	13897	135	B3-U0-G1											
VSQ-M	12054	117				B4-U0-G2	12578	122	B4-U0-G2	13102	127	B4-U0-G2	13627	132	B4-U0-G2											
VSQ-W	11767	114				B4-U0-G3	12278	119	B4-U0-G3	12790	124	B4-U0-G3	13302	129	B4-U0-G3											
II-HS	8518	83				B1-U0-G2	8889	86	B1-U0-G2	9259	90	B1-U0-G2	9629	93	B1-U0-G2											
II-FR-HS	8665	84				B1-U0-G1	9042	88	B1-U0-G1	9418	91	B1-U0-G1	9795	95	B1-U0-G1											
III-M-HS	8618	84				B1-U0-G2	8992	87	B1-U0-G2	9367	91	B1-U0-G2	9741	94	B1-U0-G2											
III-W-HS	8436	82				B1-U0-G2	8802	85	B1-U0-G2	9169	89	B1-U0-G2	9536	92	B1-U0-G3											
IV-HS	8901	86				B1-U0-G2	9288	90	B1-U0-G2	9675	94	B1-U0-G2	10062	98	B1-U0-G2											
IV-FT-HS	8413	82				B1-U0-G3	8778	85	B1-U0-G3	9144	89	B1-U0-G3	9510	92	B1-U0-G3											

IES File downloads for this product can be found at [www.usalgt.com/downloads/asr.html](http://www.usalgt.com/downloads/asr.html)

## PHOTOMETRIC DATA GUIDE - LUMEN TABLES (PAC-PLED)

PAC24-PLED																								
LED Count	Drive Current (mA)	System Watts	Dist'n Type	27K (2700K - 70CRI)			30K (3000K - 70CRI)			40K (4000K - 70CRI)			50K (5000K - 70CRI)			System Watts	TRA (590nm)							
				LUMENS	LPW	BUG RATING	LUMENS	LPW	BUG RATING	LUMENS	LPW	BUG RATING	LUMENS	LPW	BUG RATING		LUMENS	LPW	BUG RATING					
48	350	53.6	II	7280	136	B2-U0-G2	7596	142	B2-U0-G2	7913	148	B2-U0-G2	8229	154	B2-U0-G2	41.3	2532	61	B1-U0-G1					
			II-FR	7329	137	B2-U0-G1	7648	143	B2-U0-G1	7967	149	B2-U0-G1	8285	155	B2-U0-G1		2549	62	B1-U0-G1					
			III-M	7407	138	B2-U0-G2	7729	144	B2-U0-G2	8052	150	B2-U0-G2	8374	156	B2-U0-G2		2577	62	B1-U0-G1					
			III-W	6878	128	B1-U0-G2	7177	134	B1-U0-G2	7476	139	B1-U0-G2	7775	145	B1-U0-G2		2392	58	B1-U0-G1					
			IV	7351	137	B2-U0-G2	7671	143	B2-U0-G2	7991	149	B2-U0-G2	8310	155	B2-U0-G2		2557	62	B1-U0-G1					
			IV-FT	6697	125	B1-U0-G2	6988	130	B1-U0-G2	7279	136	B2-U0-G2	7570	141	B2-U0-G2		2329	56	B1-U0-G1					
			VSQ-N	7685	143	B2-U0-G1	8019	150	B3-U0-G1	8353	156	B3-U0-G1	8687	162	B3-U0-G1		2673	65	B1-U0-G0					
			VSQ-M	7534	141	B3-U0-G1	7862	147	B3-U0-G2	8190	153	B3-U0-G2	8517	159	B3-U0-G2		2621	63	B2-U0-G1					
			VSQ-W	7355	137	B3-U0-G2	7674	143	B3-U0-G2	7994	149	B3-U0-G2	8314	155	B3-U0-G2		2558	62	B2-U0-G1					
			II-HS	5324	99	B1-U0-G2	5556	104	B1-U0-G2	5787	108	B1-U0-G2	6019	112	B1-U0-G2		1852	45	B0-U0-G1					
			II-FR-HS	5416	101	B0-U0-G1	5652	105	B1-U0-G1	5887	110	B1-U0-G1	6123	114	B1-U0-G1		1884	46	B0-U0-G0					
			III-M-HS	5386	100	B0-U0-G2	5620	105	B0-U0-G2	5854	109	B0-U0-G2	6089	114	B0-U0-G2		1873	45	B0-U0-G1					
			III-W-HS	5272	98	B0-U0-G2	5501	103	B0-U0-G2	5731	107	B0-U0-G2	5960	111	B0-U0-G2		1834	44	B0-U0-G1					
			IV-HS	5563	104	B0-U0-G2	5805	108	B0-U0-G2	6047	113	B0-U0-G2	6288	117	B0-U0-G2		1935	47	B0-U0-G1					
			IV-FT-HS	5258	98	B0-U0-G2	5487	102	B0-U0-G2	5715	107	B0-U0-G2	5944	111	B0-U0-G2		1829	44	B0-U0-G1					
			48	525	80.7	II	10351	128	B2-U0-G2	10801	134	B2-U0-G2	11251	139	B2-U0-G2		11701	145	B2-U0-G2	62.1	2925	47	B1-U0-G1	
						II-FR	10420	129	B2-U0-G1	10873	135	B2-U0-G1	11326	140	B3-U0-G1		11779	146	B3-U0-G1		2945	47	B1-U0-G1	
						III-M	10532	131	B2-U0-G2	10990	136	B2-U0-G2	11448	142	B2-U0-G2		11906	148	B2-U0-G2		2976	48	B1-U0-G1	
III-W	9780	121				B2-U0-G3	10205	126	B2-U0-G3	10630	132	B2-U0-G3	11055	137	B2-U0-G3	2764	45	B1-U0-G1						
IV	10453	130				B2-U0-G2	10907	135	B2-U0-G2	11362	141	B2-U0-G2	11816	146	B2-U0-G2	2954	48	B1-U0-G1						
IV-FT	9522	118				B2-U0-G3	9936	123	B2-U0-G3	10350	128	B2-U0-G3	10764	133	B2-U0-G3	2691	43	B1-U0-G1						
VSQ-N	10925	135				B3-U0-G1	11400	141	B3-U0-G1	11875	147	B3-U0-G1	12350	153	B3-U0-G1	3088	50	B1-U0-G0						
VSQ-M	10713	133				B4-U0-G2	11178	139	B4-U0-G2	11644	144	B4-U0-G2	12110	150	B4-U0-G2	3027	49	B2-U0-G1						
VSQ-W	10459	130				B4-U0-G3	10913	135	B4-U0-G3	11368	141	B4-U0-G3	11823	147	B4-U0-G3	2955	48	B2-U0-G1						
II-HS	7570	94				B1-U0-G2	7900	98	B1-U0-G2	8229	102	B1-U0-G2	8558	106	B1-U0-G2	2139	34	B0-U0-G1						
II-FR-HS	7700	95				B1-U0-G1	8035	100	B1-U0-G1	8370	104	B1-U0-G1	8705	108	B1-U0-G1	2176	35	B0-U0-G0						
III-M-HS	7658	95				B1-U0-G2	7991	99	B1-U0-G2	8324	103	B1-U0-G2	8657	107	B1-U0-G2	2164	35	B0-U0-G1						
III-W-HS	7496	93				B0-U0-G2	7822	97	B0-U0-G2	8148	101	B1-U0-G2	8474	105	B1-U0-G2	2118	34	B0-U0-G1						
IV-HS	7910	98				B1-U0-G2	8254	102	B1-U0-G2	8598	107	B1-U0-G2	8942	111	B1-U0-G2	2235	36	B0-U0-G1						
IV-FT-HS	7476	93				B1-U0-G3	7801	97	B1-U0-G3	8126	101	B1-U0-G3	8451	105	B1-U0-G3	2113	34	B0-U0-G1						
48	700	108.0				II	13020	121	B2-U0-G2	13586	126	B2-U0-G2	14152	131	B2-U0-G2	14718	136	B3-U0-G2	N/A		N/A			
						II-FR	13106	121	B3-U0-G1	13676	127	B3-U0-G1	14246	132	B3-U0-G1	14816	137	B3-U0-G2						
						III-M	13247	123	B2-U0-G2	13823	128	B2-U0-G2	14399	133	B2-U0-G2	14975	139	B2-U0-G2						
			III-W	12299	114	B2-U0-G3	12834	119	B2-U0-G3	13369	124	B2-U0-G3	13903	129	B2-U0-G3									
			IV	13147	122	B2-U0-G2	13719	127	B2-U0-G2	14291	132	B2-U0-G2	14862	138	B2-U0-G2									
			IV-FT	11976	111	B2-U0-G3	12497	116	B2-U0-G3	13017	121	B2-U0-G3	13538	125	B2-U0-G3									
			VSQ-N	13741	127	B3-U0-G1	14338	133	B3-U0-G1	14936	138	B3-U0-G1	15533	144	B3-U0-G1									
			VSQ-M	13475	125	B4-U0-G2	14061	130	B4-U0-G2	14647	136	B4-U0-G2	15233	141	B4-U0-G2									
			VSQ-W	13153	122	B4-U0-G3	13725	127	B4-U0-G3	14297	132	B4-U0-G3	14869	138	B4-U0-G3									
			II-HS	9522	88	B1-U0-G2	9936	92	B1-U0-G2	10350	96	B1-U0-G2	10763	100	B1-U0-G2									
			II-FR-HS	9685	90	B1-U0-G1	10106	94	B1-U0-G1	10527	97	B1-U0-G1	10948	101	B1-U0-G1									
			III-M-HS	9632	89	B1-U0-G2	10051	93	B1-U0-G2	10469	97	B1-U0-G2	10888	101	B1-U0-G2									
			III-W-HS	9428	87	B1-U0-G3	9838	91	B1-U0-G3	10248	95	B1-U0-G3	10658	99	B1-U0-G3									
			IV-HS	9950	92	B1-U0-G2	10382	96	B1-U0-G2	10815	100	B1-U0-G2	11247	104	B1-U0-G2									
			IV-FT-HS	9403	87	B1-U0-G3	9812	91	B1-U0-G3	10221	95	B1-U0-G3	10630	98	B1-U0-G3									
			48	875	134.7	II	15335	114	B3-U0-G2	16001	119	B3-U0-G3	16668	124	B3-U0-G3	17335	129	B3-U0-G3		N/A			N/A	
						II-FR	15437	115	B3-U0-G2	16108	120	B3-U0-G2	16779	125	B3-U0-G2	17450	130	B3-U0-G2						
						III-M	15602	116	B3-U0-G2	16281	121	B3-U0-G3	16959	126	B3-U0-G3	17637	131	B3-U0-G3						
III-W	14487	108				B2-U0-G3	15117	112	B2-U0-G3	15746	117	B3-U0-G3	16376	122	B3-U0-G3									
IV	15485	115				B3-U0-G2	16159	120	B3-U0-G2	16832	125	B3-U0-G3	17505	130	B3-U0-G3									
IV-FT	14107	105				B2-U0-G3	14720	109	B3-U0-G3	15333	114	B3-U0-G3	15947	118	B3-U0-G3									
VSQ-N	16186	120				B4-U0-G1	16889	125	B4-U0-G2	17593	131	B4-U0-G2	18297	136	B4-U0-G2									
VSQ-M	15871	118				B4-U0-G2	16561	123	B4-U0-G2	17251	128	B4-U0-G2	17941	133	B4-U0-G2									
VSQ-W	15492	115				B4-U0-G3	16166	120	B4-U0-G3	16839	125	B4-U0-G3	17513	130	B5-U0-G3									
II-HS	11215	83				B1-U0-G2	11703	87	B1-U0-G2	12190	90	B1-U0-G2	12678	94	B1-U0-G2									
II-FR-HS	11408	85				B1-U0-G2	11904	88	B1-U0-G2	12400	92	B1-U0-G2	12896	96	B1-U0-G2									
III-M-HS	11346	84				B1-U0-G2	11839	88	B1-U0-G3	12332	92	B1-U0-G3	12826	95	B1-U0-G3									
III-W-HS	11106	82				B1-U0-G3	11589	86	B1-U0-G3	12072	90	B1-U0-G3	12555	93	B1-U0-G3									
IV-HS	11719	87				B1-U0-G2	12229	91	B1-U0-G2	12738	95	B1-U0-G2	13248	98	B1-U0-G3									
IV-FT-HS	11076	82				B1-U0-G3	11557	86	B1-U0-G3	12039	89	B1-U0-G3	12521	93	B1-U0-G3									

IES File downloads for this product can be found at [www.usalgt.com/downloads/asr.html](http://www.usalgt.com/downloads/asr.html)



## PHOTOMETRIC DATA GUIDE - LUMEN TABLES (PAC-PLED)

PAC24-PLED																								
LED Count	Drive Current (mA)	System Watts	Dist'n Type	27K (2700K - 70CRI)			30K (3000K - 70CRI)			40K (4000K - 70CRI)			50K (5000K - 70CRI)			System Watts	TRA (590nm)							
				LUMENS	LPW	BUG RATING	LUMENS	LPW	BUG RATING	LUMENS	LPW	BUG RATING	LUMENS	LPW	BUG RATING		LUMENS	LPW	BUG RATING					
80	350	85.8	II	11652	136	B2-U0-G2	12159	142	B2-U0-G2	12665	148	B2-U0-G2	13172	154	B2-U0-G2	66.1	4053	61	B1-U0-G1					
			II-FR	11730	137	B3-U0-G1	12240	143	B3-U0-G1	12750	149	B3-U0-G1	13260	155	B3-U0-G1		4080	62	B1-U0-G1					
			III-M	11856	138	B2-U0-G2	12371	144	B2-U0-G2	12887	150	B2-U0-G2	13403	156	B2-U0-G2		4124	62	B1-U0-G1					
			III-W	11008	128	B2-U0-G3	11487	134	B2-U0-G3	11965	139	B2-U0-G3	12444	145	B2-U0-G3		3829	58	B1-U0-G1					
			IV	11767	137	B2-U0-G2	12279	143	B2-U0-G2	12790	149	B2-U0-G2	13302	155	B2-U0-G2		4093	62	B1-U0-G1					
			IV-FT	10719	125	B2-U0-G3	11185	130	B2-U0-G3	11651	136	B2-U0-G3	12117	141	B2-U0-G3		3728	56	B1-U0-G2					
			VSQ-N	12299	143	B3-U0-G1	12833	150	B3-U0-G1	13368	156	B3-U0-G1	13903	162	B3-U0-G1		4278	65	B2-U0-G0					
			VSQ-M	12060	141	B4-U0-G2	12584	147	B4-U0-G2	13109	153	B4-U0-G2	13633	159	B4-U0-G2		4195	63	B2-U0-G1					
			VSQ-W	11772	137	B4-U0-G3	12284	143	B4-U0-G3	12796	149	B4-U0-G3	13308	155	B4-U0-G3		4095	62	B3-U0-G1					
			II-HS	8522	99	B1-U0-G2	8892	104	B1-U0-G2	9263	108	B1-U0-G2	9633	112	B1-U0-G2		2964	45	B0-U0-G1					
			II-FR-HS	8669	101	B1-U0-G1	9046	105	B1-U0-G1	9422	110	B1-U0-G1	9799	114	B1-U0-G1		3015	46	B0-U0-G0					
			III-M-HS	8622	100	B1-U0-G2	8997	105	B1-U0-G2	9371	109	B1-U0-G2	9746	114	B1-U0-G2		2999	45	B0-U0-G1					
			III-W-HS	8439	98	B1-U0-G2	8806	103	B1-U0-G2	9173	107	B1-U0-G2	9540	111	B1-U0-G3		2935	44	B0-U0-G1					
			IV-HS	8905	104	B1-U0-G2	9292	108	B1-U0-G2	9679	113	B1-U0-G2	10066	117	B1-U0-G2		3097	47	B0-U0-G1					
			IV-FT-HS	8416	98	B1-U0-G3	8782	102	B1-U0-G3	9148	107	B1-U0-G3	9514	111	B1-U0-G3		2927	44	B0-U0-G1					
			80	525	129.7	II	16744	129	B3-U0-G3	17472	135	B3-U0-G3	18200	140	B3-U0-G3		18928	146	B3-U0-G3	99.9	4732	47	B1-U0-G1	
						II-FR	16857	130	B3-U0-G2	17589	136	B3-U0-G2	18322	141	B3-U0-G2		19055	147	B3-U0-G2		4764	48	B1-U0-G1	
						III-M	17037	131	B3-U0-G3	17778	137	B3-U0-G3	18518	143	B3-U0-G3		19259	148	B3-U0-G3		4815	48	B1-U0-G1	
III-W	15819	122				B3-U0-G3	16507	127	B3-U0-G3	17195	133	B3-U0-G3	17882	138	B3-U0-G3	4471	45	B1-U0-G2						
IV	16909	130				B3-U0-G3	17644	136	B3-U0-G3	18379	142	B3-U0-G3	19114	147	B3-U0-G3	4779	48	B1-U0-G1						
IV-FT	15403	119				B3-U0-G3	16073	124	B3-U0-G4	16742	129	B3-U0-G4	17412	134	B3-U0-G4	4353	44	B1-U0-G2						
VSQ-N	17673	136				B4-U0-G2	18441	142	B4-U0-G2	19210	148	B4-U0-G2	19978	154	B4-U0-G2	4994	50	B2-U0-G1						
VSQ-M	17331	134				B4-U0-G2	18084	139	B4-U0-G2	18837	145	B4-U0-G2	19591	151	B4-U0-G2	4898	49	B3-U0-G1						
VSQ-W	16917	130				B5-U0-G3	17652	136	B5-U0-G3	18387	142	B5-U0-G3	19123	147	B5-U0-G3	4781	48	B3-U0-G2						
II-HS	12246	94				B1-U0-G2	12778	99	B1-U0-G2	13311	103	B1-U0-G3	13843	107	B1-U0-G3	3461	35	B0-U0-G1						
II-FR-HS	12457	96				B1-U0-G2	12998	100	B1-U0-G2	13540	104	B1-U0-G2	14081	109	B1-U0-G2	3520	35	B0-U0-G1						
III-M-HS	12389	96				B1-U0-G3	12928	100	B1-U0-G3	13466	104	B1-U0-G3	14005	108	B1-U0-G3	3501	35	B0-U0-G1						
III-W-HS	12127	93				B1-U0-G3	12654	98	B1-U0-G3	13181	102	B1-U0-G3	13708	106	B1-U0-G3	3427	34	B0-U0-G1						
IV-HS	12797	99				B1-U0-G2	13353	103	B1-U0-G3	13909	107	B1-U0-G3	14465	112	B1-U0-G3	3616	36	B0-U0-G1						
IV-FT-HS	12093	93				B1-U0-G3	12619	97	B1-U0-G3	13145	101	B1-U0-G3	13671	105	B1-U0-G3	3418	34	B0-U0-G2						
80	700	173.5				II	21195	122	B3-U0-G3	22116	127	B3-U0-G3	23038	133	B3-U0-G3	23960	138	B3-U0-G3	N/A		N/A			
						II-FR	21337	123	B3-U0-G2	22265	128	B3-U0-G2	23193	134	B3-U0-G2	24121	139	B3-U0-G2						
						III-M	21566	124	B3-U0-G3	22504	130	B3-U0-G3	23441	135	B3-U0-G3	24379	141	B3-U0-G4						
			III-W	20024	115	B3-U0-G4	20894	120	B3-U0-G4	21765	125	B3-U0-G4	22636	130	B3-U0-G4									
			IV	21404	123	B3-U0-G3	22335	129	B3-U0-G3	23265	134	B3-U0-G3	24196	139	B3-U0-G3									
			IV-FT	19498	112	B3-U0-G4	20346	117	B3-U0-G4	21193	122	B3-U0-G4	22041	127	B3-U0-G4									
			VSQ-N	22371	129	B4-U0-G2	23343	135	B4-U0-G2	24316	140	B4-U0-G2	25289	146	B4-U0-G2									
			VSQ-M	21937	126	B5-U0-G3	22891	132	B5-U0-G3	23845	137	B5-U0-G3	24799	143	B5-U0-G3									
			VSQ-W	21413	123	B5-U0-G4	22344	129	B5-U0-G4	23275	134	B5-U0-G4	24206	140	B5-U0-G4									
			II-HS	15501	89	B1-U0-G3	16175	93	B1-U0-G3	16849	97	B1-U0-G3	17523	101	B1-U0-G3									
			II-FR-HS	15768	91	B1-U0-G2	16454	95	B1-U0-G2	17139	99	B1-U0-G2	17824	103	B1-U0-G2									
			III-M-HS	15683	90	B1-U0-G3	16365	94	B1-U0-G3	17046	98	B1-U0-G3	17728	102	B1-U0-G4									
			III-W-HS	15350	88	B1-U0-G4	16018	92	B1-U0-G4	16685	96	B1-U0-G4	17353	100	B1-U0-G4									
			IV-HS	16198	93	B1-U0-G3	16902	97	B1-U0-G3	17606	101	B1-U0-G3	18310	106	B1-U0-G3									
			IV-FT-HS	15308	88	B1-U0-G4	15974	92	B1-U0-G4	16639	96	B1-U0-G4	17305	100	B1-U0-G4									
			80	875	221.5	II	25400	115	B3-U0-G3	26504	120	B3-U0-G4	27608	125	B3-U0-G4	28713	130	B3-U0-G4		N/A			N/A	
						II-FR	25570	115	B3-U0-G2	26682	120	B3-U0-G2	27794	125	B3-U0-G2	28905	130	B4-U0-G2						
						III-M	25844	117	B3-U0-G4	26967	122	B3-U0-G4	28091	127	B3-U0-G4	29215	132	B3-U0-G4						
III-W	23996	108				B3-U0-G4	25040	113	B3-U0-G4	26083	118	B3-U0-G4	27126	122	B3-U0-G4									
IV	25650	116				B3-U0-G4	26765	121	B3-U0-G4	27880	126	B3-U0-G4	28996	131	B3-U0-G4									
IV-FT	23365	105				B3-U0-G4	24381	110	B3-U0-G5	25397	115	B3-U0-G5	26413	119	B3-U0-G5									
VSQ-N	26808	121				B5-U0-G2	27974	126	B5-U0-G2	29139	132	B5-U0-G2	30305	137	B5-U0-G2									
VSQ-M	26289	119				B5-U0-G3	27432	124	B5-U0-G3	28575	129	B5-U0-G3	29718	134	B5-U0-G3									
VSQ-W	25661	116				B5-U0-G4	26777	121	B5-U0-G4	27893	126	B5-U0-G4	29008	131	B5-U0-G4									
II-HS	18576	84				B1-U0-G3	19384	88	B1-U0-G3	20191	91	B1-U0-G4	20999	95	B2-U0-G4									
II-FR-HS	18896	85				B1-U0-G2	19717	89	B1-U0-G2	20539	93	B1-U0-G2	21360	96	B1-U0-G2									
III-M-HS	18794	85				B1-U0-G4	19611	89	B1-U0-G4	20428	92	B1-U0-G4	21245	96	B1-U0-G4									
III-W-HS	18395	83				B1-U0-G4	19195	87	B1-U0-G4	19995	90	B1-U0-G4	20795	94	B1-U0-G4									
IV-HS	19411	88				B1-U0-G4	20255	91	B1-U0-G4	21099	95	B1-U0-G4	21943	99	B1-U0-G4									
IV-FT-HS	18345	83				B1-U0-G4	19143	86	B1-U0-G4	19940	90	B1-U0-G4	20738	94	B1-U0-G4									

IES File downloads for this product can be found at [www.usalgt.com/downloads/asr.html](http://www.usalgt.com/downloads/asr.html)

## PHOTOMETRIC DATA GUIDE - ISOFOOTCANDLE PLOTS

PAC18-PLED-AL-48LED-525mA-40K - 16' Mounting Height (14' Pole)

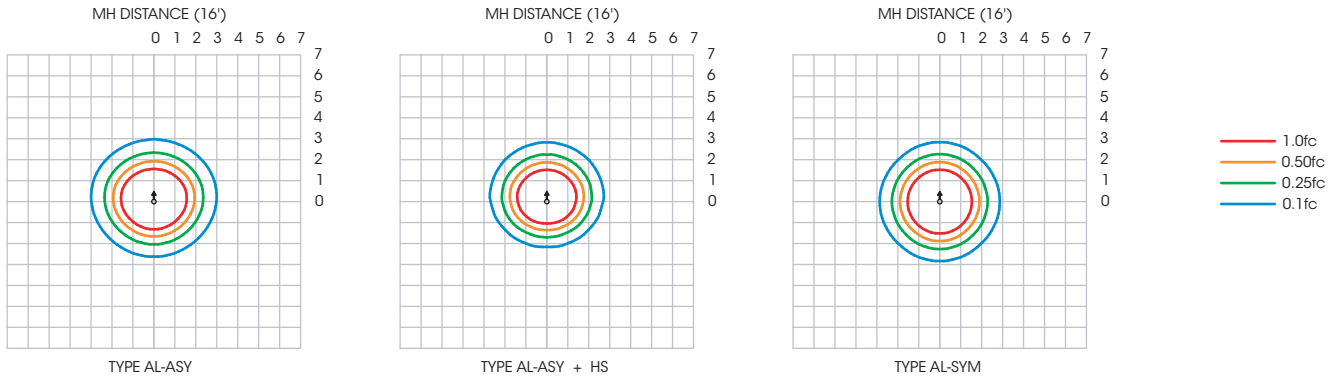

## PHOTOMETRIC DATA GUIDE - LUMEN TABLES (PAC-PLED-AL)

PAC18-PLED-AL																			
LED Count	Drive Current (mA)	System Watts	Dist'n Type	27K (2700K - 70CRI)			30K (3000K - 70CRI)			40K (4000K - 70CRI)			50K (5000K - 70CRI)			System Watts	TRA (590nm)		
				LUMENS	LPW	BUG RATING	LUMENS	LPW	BUG RATING	LUMENS	LPW	BUG RATING	LUMENS	LPW	BUG RATING		LUMENS	LPW	BUG RATING
48	175	26.5	ASY	2953	111	B1-U0-G1	3081	116	B1-U0-G1	3210	121	B1-U0-G1	3338	126	B1-U0-G1	20.4	1156	57	B1-U0-G1
			SYM	2956	112	B1-U0-G1	3085	116	B1-U0-G1	3213	121	B1-U0-G1	3342	126	B1-U0-G1		1157	57	B1-U0-G0
			ASY-HS	2113	80	B1-U0-G1	2205	83	B1-U0-G1	2297	87	B1-U0-G1	2389	90	B1-U0-G1		827	41	B0-U0-G0
48	350	53.6	ASY	5572	104	B2-U0-G1	5814	108	B2-U0-G1	6057	113	B2-U0-G1	6299	118	B2-U0-G2	41.3	1938	47	B1-U0-G1
			SYM	5578	104	B2-U0-G1	5820	109	B2-U0-G1	6063	113	B2-U0-G1	6306	118	B2-U0-G1		1940	47	B1-U0-G0
			ASY-HS	3987	74	B1-U0-G1	4160	78	B1-U0-G1	4334	81	B1-U0-G1	4508	84	B1-U0-G1		1387	34	B1-U0-G0
48	525	80.7	ASY	7923	98	B2-U0-G2	8268	102	B3-U0-G2	8612	107	B3-U0-G2	8957	111	B3-U0-G2	62.1	2239	36	B1-U0-G1
			SYM	7932	98	B3-U0-G1	8276	103	B3-U0-G1	8622	107	B3-U0-G1	8966	111	B3-U0-G1		2241	36	B1-U0-G1
			ASY-HS	5670	70	B2-U0-G1	5916	73	B2-U0-G1	6163	76	B2-U0-G1	6409	79	B2-U0-G1		1602	26	B1-U0-G1
48	700	108.0	ASY	9968	92	B3-U0-G2	10401	96	B3-U0-G2	10835	100	B3-U0-G2	11268	104	B3-U0-G2	N/A	N/A		
			SYM	9979	92	B3-U0-G1	10413	96	B3-U0-G1	10847	100	B3-U0-G1	11280	104	B3-U0-G1		N/A		
			ASY-HS	7133	66	B2-U0-G1	7443	69	B2-U0-G1	7753	72	B2-U0-G1	8063	75	B2-U0-G2		N/A		
48	875	134.7	ASY	11734	87	B3-U0-G2	12245	91	B3-U0-G2	12755	95	B3-U0-G3	13265	98	B3-U0-G3	N/A	N/A		
			SYM	11747	87	B3-U0-G1	12258	91	B3-U0-G1	12769	95	B3-U0-G1	13279	99	B3-U0-G1		N/A		
			ASY-HS	8397	62	B2-U0-G2	8762	65	B2-U0-G2	9127	68	B2-U0-G2	9492	70	B3-U0-G2		N/A		

IES File downloads for this product can be found at [www.usalgt.com/downloads/asr.html](http://www.usalgt.com/downloads/asr.html)



## PHOTOMETRIC DATA GUIDE - ISOFOOTCANDLE PLOTS

PAC24-PLED-AL-80LED-525mA-40K - 20' Mounting Height (18' Pole)

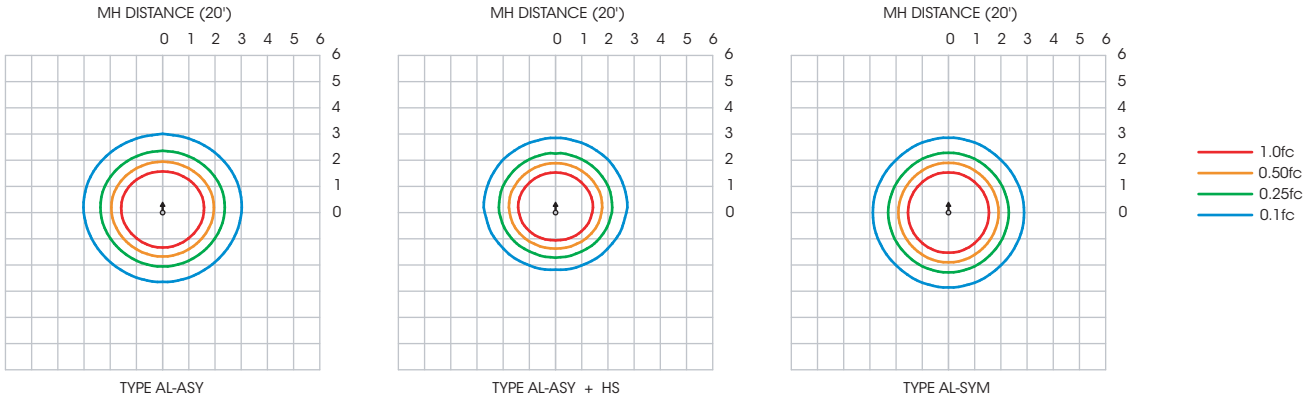

## PHOTOMETRIC DATA GUIDE - LUMEN TABLES (PAC-PLED-AL)

PAC24-PLED-AL																			
LED Count	Drive Current (mA)	System Watts	Dist'n Type	27K (2700K - 70CRI)			30K (3000K - 70CRI)			40K (4000K - 70CRI)			50K (5000K - 70CRI)			System Watts	TRA (590nm)		
				LUMENS	LPW	BUG RATING	LUMENS	LPW	BUG RATING	LUMENS	LPW	BUG RATING	LUMENS	LPW	BUG RATING		LUMENS	LPW	BUG RATING
80	175	41.9	ASY	4725	113	B2-U0-G1	4930	118	B2-U0-G1	5136	123	B2-U0-G1	5341	127	B2-U0-G1	32.3	1849	57	B1-U0-G1
			SYM	4730	113	B2-U0-G1	4936	118	B2-U0-G1	5141	123	B2-U0-G1	5347	128	B2-U0-G1		1851	57	B1-U0-G0
			ASY-HS	3381	81	B1-U0-G1	3529	84	B1-U0-G1	3676	88	B1-U0-G1	3822	91	B1-U0-G1		1323	41	B1-U0-G0
80	350	85.8	ASY	8915	104	B3-U0-G2	9303	108	B3-U0-G2	9691	113	B3-U0-G2	10078	117	B3-U0-G2	66.1	3101	47	B1-U0-G1
			SYM	8925	104	B3-U0-G1	9312	109	B3-U0-G1	9700	113	B3-U0-G1	10089	118	B3-U0-G1		3104	47	B1-U0-G1
			ASY-HS	6379	74	B2-U0-G1	6657	78	B2-U0-G1	6934	81	B2-U0-G1	7212	84	B2-U0-G1		2219	34	B1-U0-G1
80	525	129.7	ASY	12677	98	B3-U0-G3	13228	102	B3-U0-G3	13779	106	B3-U0-G3	14331	110	B3-U0-G3	99.9	3583	36	B1-U0-G1
			SYM	12691	98	B3-U0-G1	13242	102	B3-U0-G1	13794	106	B3-U0-G1	14346	111	B3-U0-G1		3587	36	B1-U0-G1
			ASY-HS	9072	70	B2-U0-G2	9466	73	B3-U0-G2	9860	76	B3-U0-G2	10255	79	B3-U0-G2		2564	26	B1-U0-G1
80	700	173.5	ASY	15949	92	B3-U0-G3	16642	96	B3-U0-G3	17335	100	B3-U0-G3	18030	104	B3-U0-G3	N/A	N/A		
			SYM	15967	92	B3-U0-G1	16660	96	B3-U0-G1	17355	100	B3-U0-G1	18049	104	B3-U0-G1		N/A		
			ASY-HS	11413	66	B3-U0-G2	11909	69	B3-U0-G2	12405	71	B3-U0-G2	12901	74	B3-U0-G2		N/A		
80	875	221.5	ASY	18775	85	B3-U0-G3	19592	88	B3-U0-G3	20408	92	B3-U0-G3	21224	96	B4-U0-G3	N/A	N/A		
			SYM	18796	85	B4-U0-G1	19613	89	B4-U0-G1	20430	92	B4-U0-G2	21247	96	B4-U0-G2		N/A		
			ASY-HS	13435	61	B3-U0-G2	14019	63	B3-U0-G2	14603	66	B3-U0-G2	15187	69	B3-U0-G2		N/A		

IES File downloads for this product can be found at [www.usaltg.com/downloads/asr.html](http://www.usaltg.com/downloads/asr.html)