

TRADITIONAL STYLED BASE

700 Series

Base

One piece corrosion resistant, durable cast aluminum construction. Minimum .210 wall thickness. Base consists of a smooth, tapered bottom section, and a highly detailed, decorative fluted section, a decorative cast aluminum Collar and a fluted Hand Hole Cover contoured to Base design. Hand Hole Cover supplied with tamper resistant hardware. Grounding Lug provided inside Base opposite hand hole.

Anchorage

A 3/4" cast aluminum anchor ring is welded 1" above bottom of base to accept (4) fully galvanized anchor bolts. Each bolt supplied with two nuts and two washers. Anchorage is fastened through hand hole.

Finish

Electrostatically applied TGIC Polyester Powder Coat on substrate prepared with 20 PSI power wash at 140°F. Four step media blast and iron phosphate pretreatment for protection and paint adhesion. 400°F bake for maximum hardness and durability.

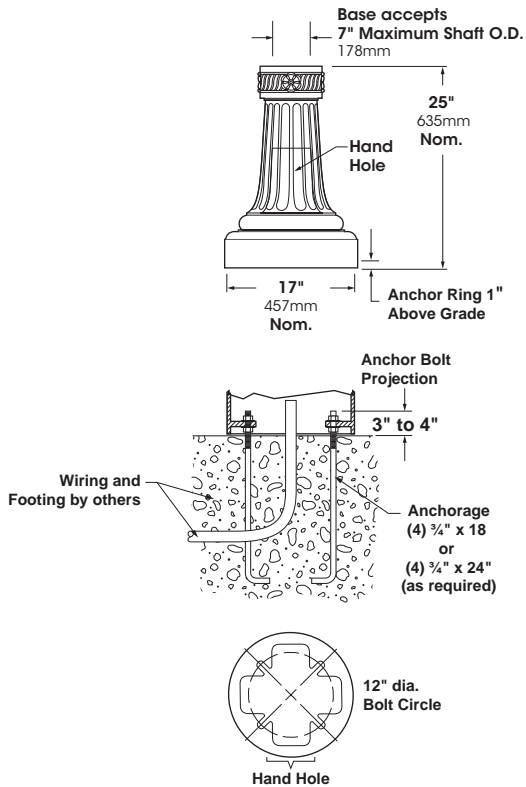
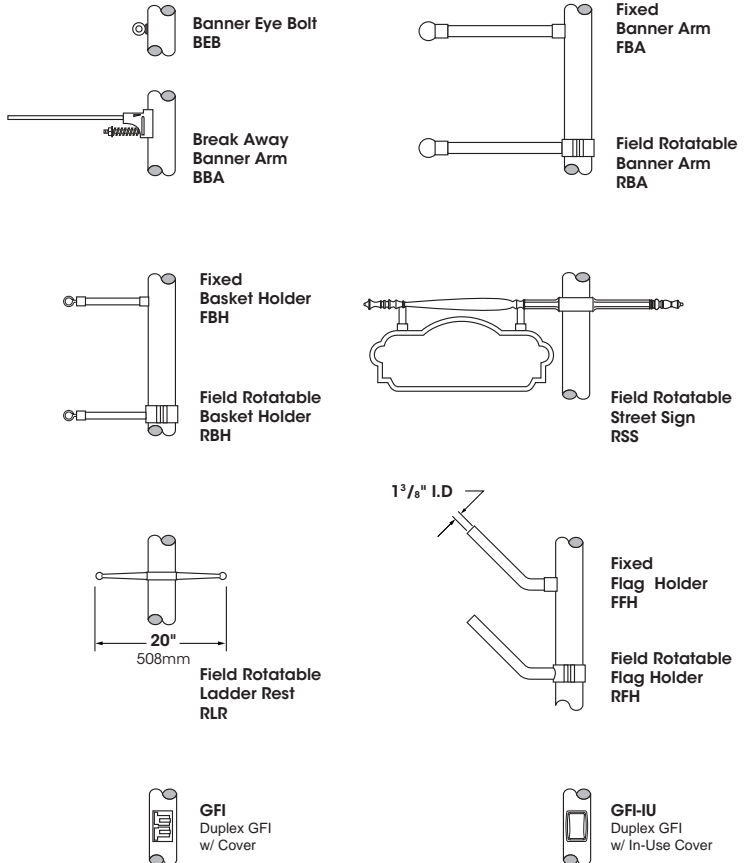
700
ANCHORAGE DATA

OPTIONS

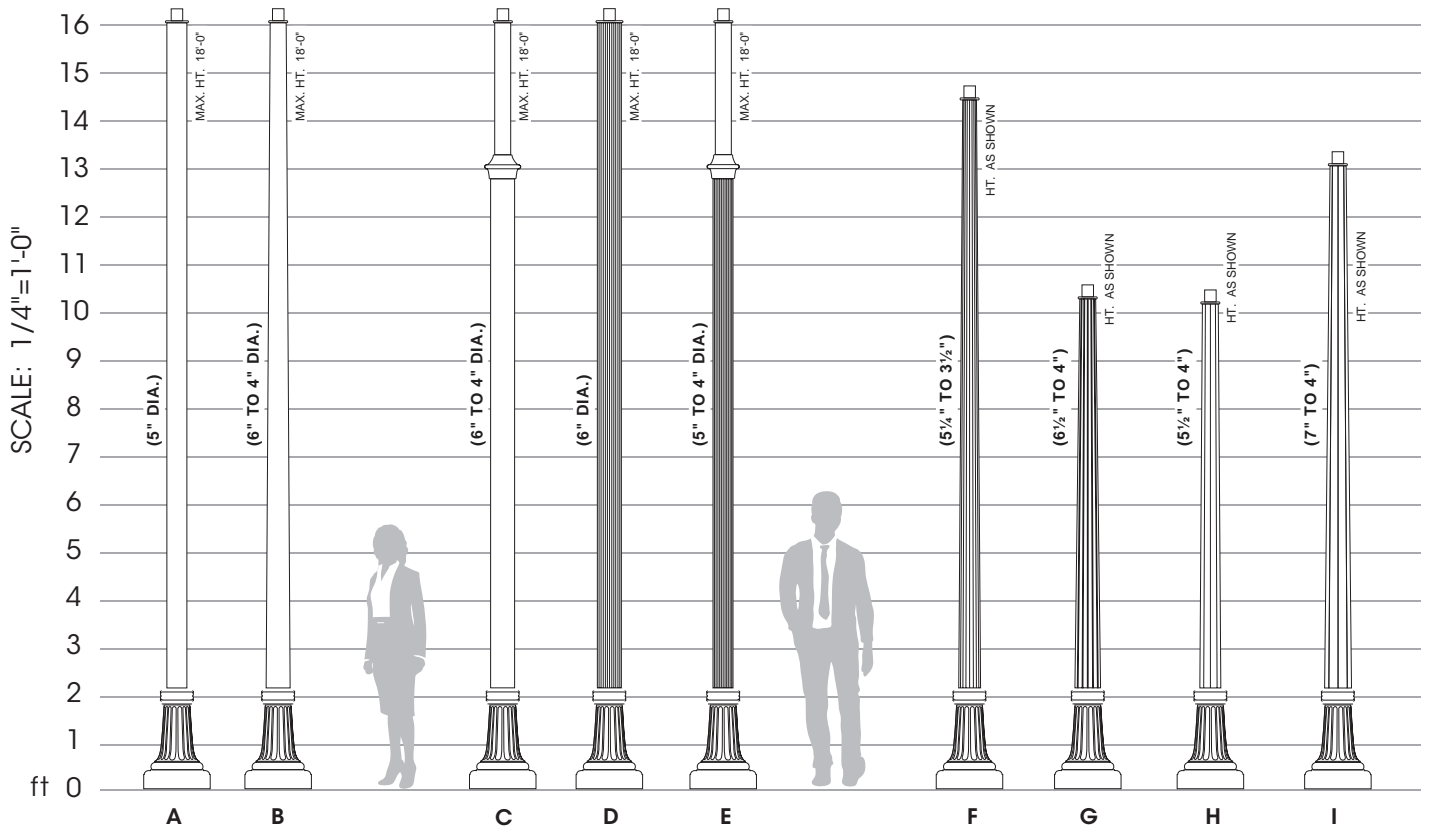
<https://www.usaltg.com/downloads/pdf/Pole-Arm-Accessories.pdf>

2024056

SAMPLE ASSEMBLIES

Finish
 Standard Textured (-T)

- Black
RAL-9005-T
- White
RAL-9003-T
- Grey
RAL-7004-T
- Dark Bronze
RAL-8019-T
- Green
RAL-6005-T

Premium Finishes

- Patina
Copper
PC
- Rust
- Custom
Specify RAL# _____
- Anodized
AZ

See USALTG.com for additional colors

- A. 7-1050-XX-PT27/OPTIONS/FINISH
- B. 7-1046T-XX-PT27/OPTIONS/FINISH
- C. 7-9040-XX-PT27/OPTIONS/FINISH
- D. 7-1080-XX-PT27/OPTIONS/FINISH
- E. 7-7040-XX-PT27/OPTIONS/FINISH
- F. 7-1030C-XX-PT27/OPTIONS/FINISH
- G. 7-1050C-XX-PT27/OPTIONS/FINISH
- H. 7-1058C-XX-PT27/OPTIONS/FINISH
- I. 7-1080C-XX-PT27/OPTIONS/FINISH

Note: XX represents height, example 10 foot and 6 inches will be written as 10'-6": 7-1040-10'-6"-PT27/OPTIONS/FINISH.

Sample Assemblies show a small offering of the Sun Valley Line of Poles & Shafts.

Please visit usaltg.com for the full product offering.