

MRB WALL MOUNT-PLED

Luminaire

Optical Crown, Arms and Hub are welded to create a one piece unitized Housing consisting of precise heavy wall cast low copper (A356 alloy; <0.2%Cu) aluminum. Hood is fastened to the Housing with a stainless steel hinge and secured with a single stainless steel hex head cap screw 180° opposite the hinge. Hood and Optical Crown are sealed with an extruded closed cell silicone gasket. Driver/wiring accessed through top of Electrical Access Hub. All exposed hardware is stainless steel.

Decorative Arm

One piece unitized decorative arm assembly and Wall Mount Plate consisting of cast low copper (A356 alloy;<0.2% Cu) aluminum. Arm is welded to the Wall Mount plate and to the decorative Support Hub. The Support Hub has either a tenon on top or the Trulevel pendant hanger. All welds are blended to create a homogeneous appearance. Wall Mount plate affixed to mounting surface covering a recessed j-box.

PLED™ Optics

Emitters (LED's) are arrayed on a metal core PCB panel with each emitter located on a copper thermal transfer pad and enclosed by an LED refractor. In asymmetric distributions, a micro-reflector inside the refractor re-directs the house side emitter output towards the street side and functions as a house side shielding element. Refractors are injection molded H12 acrylic. Each LED refractor is sealed to the PCB over an emitter and all refractors are retained by an aluminum frame. LED refractors produce standard asymmetric site/area distributions. Panels are field replaceable and field rotatable in 90° increments.

LED Driver(s)

Constant current electronic with a power factor of >.90 and a minimum operating temperature of -40°F. Driver(s) is/are UL and cUL recognized. In-line terminal blocks facilitate wiring between the driver and optical arrays. Drivers accept an input of 120-277V, 50/60Hz or 347V-480V, 50,60Hz. (0 - 10V dimmable driver is standard. Driver has a minimum of 3KV internal surge protection. Luminaire supplied with 20KV surge protector for field accessible installation.)

LED Emitters

High output LED's are utilized with drive currents ranging from 175mA to 525mA. 70CRI Minimum. LED's are available in standard Neutral White (4000K), or optional Cool White (5000K) or Warm White (3000K). Consult Factory for other LED options.

Amber LED's

TRA (True Amber) LED's utilize material that emits light in the amber spectral bandwidth only without the use of phosphors.

Finish

Electrostatically applied TGIC Polyester Powder Coat on substrate prepared with 20 PSI power wash at 140°F. Four step media blast and iron phosphate pretreatment for protection and paint adhesion. 400°F bake for maximum hardness and durability.

PROJECT NAME: _____

FIXTURE TYPE: _____

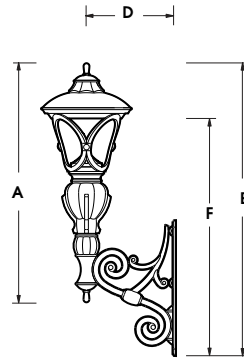
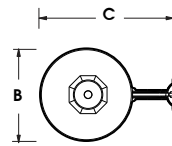
MRBT-WM (Tenon Mount)

(MRB18 shown on WM-XMB1-UT arm)

Fixture	A	B	C	D	E	F
MRB21T-WM	53" (1346mm)	21" (533mm)	28" (711mm)	17.75" (451mm)	64" (1626mm)	51.25" (1302mm)
MRB18T-WM	47.25" (1200mm)	18" (457mm)	27" (686mm)	17.75" (451mm)	58" (1473mm)	47" (1194mm)
MRB12T-WM*	33" (838mm)	12" (305mm)	15.75" (400mm)	9.25" (235mm)	37" (940mm)	28.5" (724mm)

(*MRB12-WM utilizes WM-XMB2 arm)

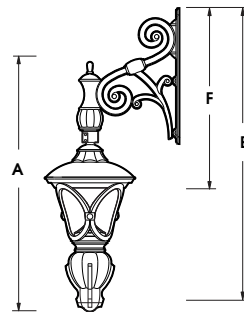
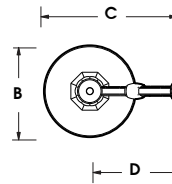
MRBP-WM (Pendant Mount)

(MRB18 shown on WM-XMB1-DP arm)

Fixture	A	B	C	D	E	F
MRB21P-WM	54.5" (1384mm)	21" (533mm)	28" (711mm)	17.75" (451mm)	65" (1651mm)	37" (940mm)
MRB18P-WM	49" (1245mm)	18" (457mm)	27" (686mm)	17.75" (451mm)	60" (1524mm)	36" (914mm)
MRB12P-WM*	34.5" (876mm)	12" (305mm)	15.75" (400mm)	9.25" (235mm)	38.5" (978mm)	21" (533mm)

(*MRB12-WM utilizes WM-XMB2 arm)

SPECIFICATIONS

PLED™ Modules

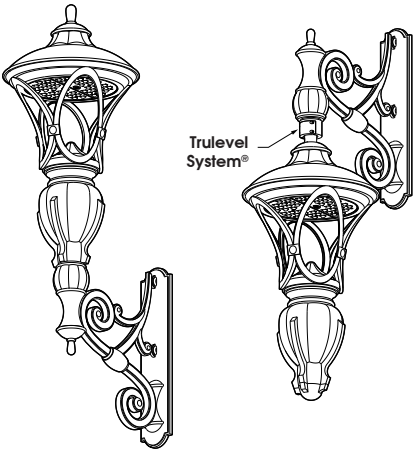

MRB21T-WM E.P.A.= 2.56
Available in:
48 LED Module Max

MRB21P-WM E.P.A.= 2.58
Available in:
48 LED Module Max

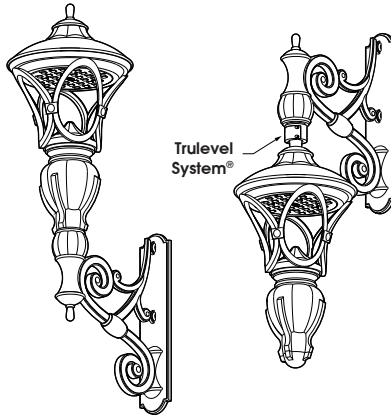

MRB18T-WM E.P.A.= 2.26
Available in:
36 LED Module Max

MRB18P-WM E.P.A.= 2.28
Available in:
36 LED Module Max

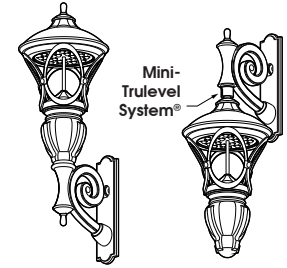

MRB12T-WM E.P.A.= 1.07
Available in:
20 LED Module Max

MRB12P-WM E.P.A.= 1.08
Available in:
20 LED Module Max

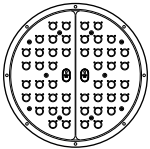

48 LED Module

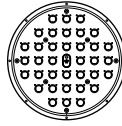

36 LED Module



20 LED Module

MRB21T-WM E.P.A.= 2.56
Available in:
48 LED Module Max

MRB21P-WM E.P.A.= 2.58
Available in:
48 LED Module Max

MRB18T-WM E.P.A.= 2.26
Available in:
36 LED Module Max

MRB18P-WM E.P.A.= 2.28
Available in:
36 LED Module Max

MRB12T-WM E.P.A.= 1.07
Available in:
20 LED Module Max

MRB12P-WM E.P.A.= 1.08
Available in:
20 LED Module Max

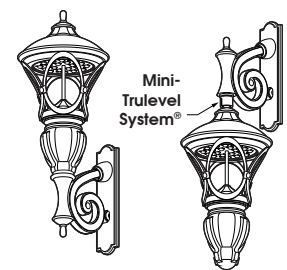
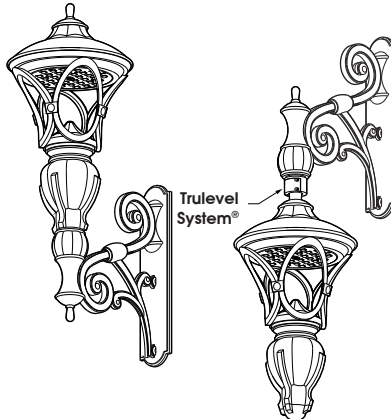
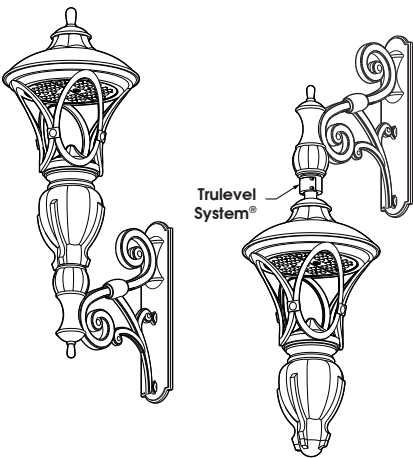

SPECIFICATIONS
Mounting Options

 WM-XMB1-UT¹

 WM-XMB1-UP¹

 WM-XMB1-DT¹

 WM-XMB1-DP¹

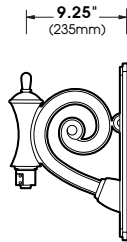
 WM-XMB2-UT²

 WM-XMB2-UP²

 WM-XMB2-DT²

 WM-XMB2-DP²

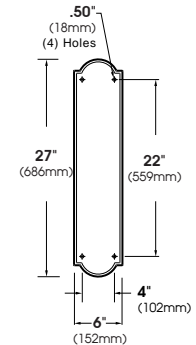
NOTES:
 1 - XMB1 arms used with MRB21 and MRB18 models
 2 - XMB2 arms used with MRB12 models

Wall Plate

MRB21 & MRB18

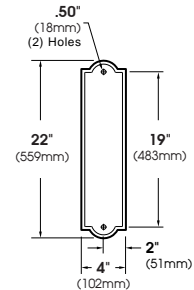







MRB12

Extruded aluminum arm and cast aluminum wall bracket assembly provided with built in gasketed wire access for fixture/supply wire connection.

SPEC/ORDERING INFORMATION

Spec/Order Example: MRB12/XMB2-UT/PLED-IV/20LED-875mA/WW/277/RAL-9005-T

Luminaire	Optics	LED Mode			Voltage	Finish	Options
Luminaire	Optics	LED			Voltage	Finish	Options
<input type="checkbox"/> WM/MRB21/XMB1-UT <input type="checkbox"/> WM/MRB21/XMB1-UP <input type="checkbox"/> WM/MRB21/XMB1-DT <input type="checkbox"/> WM/MRB21/XMB1-DP	PLED[®] Distribution Type <input type="checkbox"/> Type II PLED-II  <input type="checkbox"/> Type II Front Row PLED-II-FR  <input type="checkbox"/> Type III Med. PLED-III-M  <input type="checkbox"/> Type III Wide PLED-III-W  <input type="checkbox"/> Type IV PLED-IV  <input type="checkbox"/> Type IV PLED-IV-FT 	# of LEDs MRB21 <input type="checkbox"/> 48LED ¹ <input type="checkbox"/> 36LED <input type="checkbox"/> 20LED <hr/> MRB18 <input type="checkbox"/> 36LED ¹ <input type="checkbox"/> 20LED <hr/> MRB12 <input type="checkbox"/> 20LED ¹	Drive Current <input type="checkbox"/> 1050mA ² <input type="checkbox"/> 875mA ² <input type="checkbox"/> 700mA ² <input type="checkbox"/> 525mA <input type="checkbox"/> 350mA	Color Temp - CCT <input type="checkbox"/> NW (4000K)* * Standard <input type="checkbox"/> CW (5000K) <input type="checkbox"/> WW (3000K) Other LED Colors Available Consult Factory <input type="checkbox"/> Amber ³ <input type="checkbox"/> True Amber ⁴ TRA	<input type="checkbox"/> 120 <input type="checkbox"/> 208 <input type="checkbox"/> 240 <input type="checkbox"/> 277 <input type="checkbox"/> 347 <input type="checkbox"/> 480	Standard Textured Finish <input type="checkbox"/> Black RAL-9005-T <input type="checkbox"/> White RAL-9003-T <input type="checkbox"/> Grey RAL-7004-T <input type="checkbox"/> Dark Bronze RAL-8019-T <input type="checkbox"/> Green RAL-6005-T For smooth finish replace suffix "T" with suffix "S" (Example: RAL-9500-S) Consult factor for custom colors	<input type="checkbox"/> Internal House Side Shield inc. LED Count (Example: HS-PLED/48) HS-PLED <input type="checkbox"/> Twist Lock Receptable Only TPR <input type="checkbox"/> 7-Pin Twist Lock Receptable Only TPR7 <input type="checkbox"/> High-Low Dimming for Switch by Others/Select Levels 50/100 or 25/100 (Example: HLSW/25) HLSW <input type="checkbox"/> Photo Cell + Voltage (Example: PC120V) PC+V <input type="checkbox"/> Single Fuse (120V, 277V) SF <input type="checkbox"/> Double Fuse (208V, 240V) DF <input type="checkbox"/> Blue-Tooth Programmable Photo/Motion Sensor (Factory - Motion 50/100; Photo 75fc) MS-F311
<input type="checkbox"/> WM/MRB18/XMB1-UT <input type="checkbox"/> WM/MRB18/XMB1-UP <input type="checkbox"/> WM/MRB18/XMB1-DT <input type="checkbox"/> WM/MRB18/XMB1-DP							
<input type="checkbox"/> WM/MRB12/XMB2-UT <input type="checkbox"/> WM/MRB12/XMB2-UP <input type="checkbox"/> WM/MRB12/XMB2-DT <input type="checkbox"/> WM/MRB12/XMB2-DP							

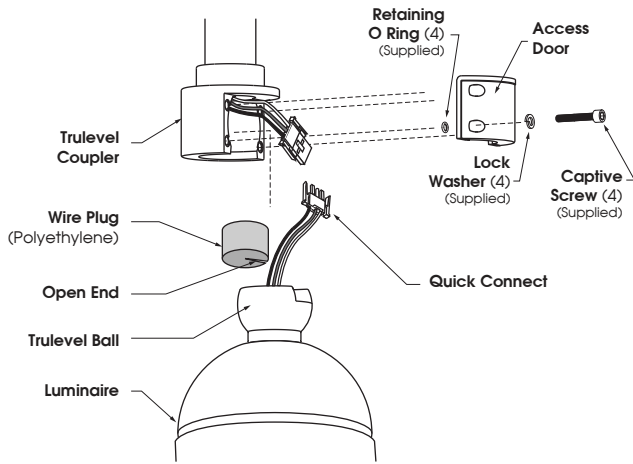
INSTALLATION DETAIL
Trulevel System® Assembly for Installation of Pendant Mount Luminaires

1. Loosen (4) Captive Screws and remove Access Door from Trulevel Coupler, pull out Quick Connect from Trulevel Coupler and Trulevel Ball.

Press open end of Wire Plug around Quick Connect wires.

Slide Wire Plug down the wires and into Trulevel Ball opening, press Neoprene firmly into opening to prevent moisture and other contaminants from entering Luminaire Assembly.

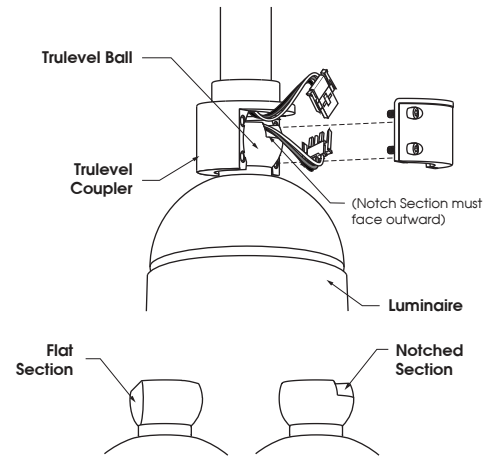

2. Place Trulevel Ball inside of Trulevel Coupler as illustrated.

A - Notched Section of Trulevel Ball must face outward as illustrated.

B - Flat Section of Trulevel Ball must face inward.

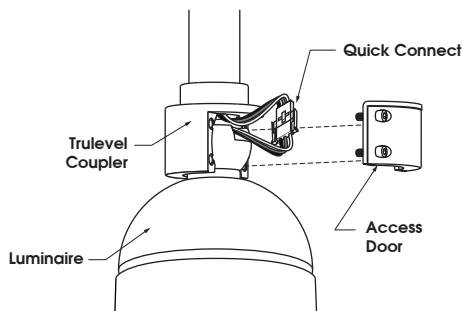

3. Connect Quick Connect components, push components inside of Trulevel Coupler cavity, replace Access Door and loosely secure, do not tighten.

Fixture will suspend without Access Door during installation.

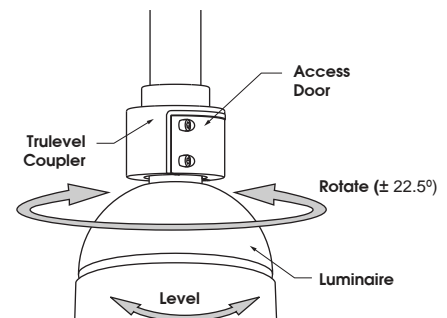

4. Rotate (left to right $\pm 22.5^\circ$) and level Luminaire to desired position. Tighten Access Door.

(Tighten each bolt to recommended torque: **10 ft-lb, foot-pound**)

Trulevel Pendant Mount is intended to allow for fixture leveling, but is not intended to be "free-swinging" upon proper installation.

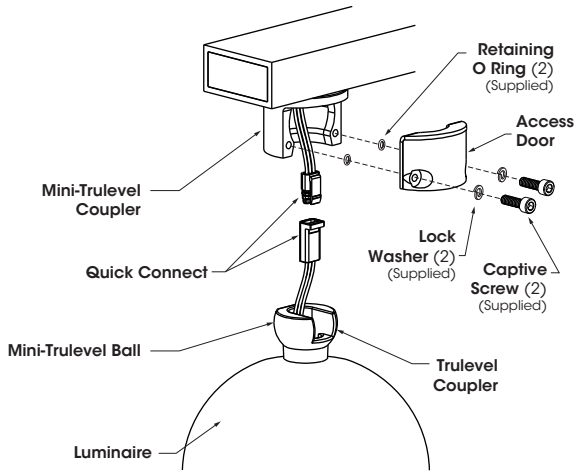
Mini-Trulevel System® Assembly for Installation of Pendant Mount Luminaires

1. Loosen (2) Captive Screws and remove Access Door from Mini-Trulevel Coupler, pull out Quick Connect from Mini-Trulevel Coupler and Mini-Trulevel Ball.

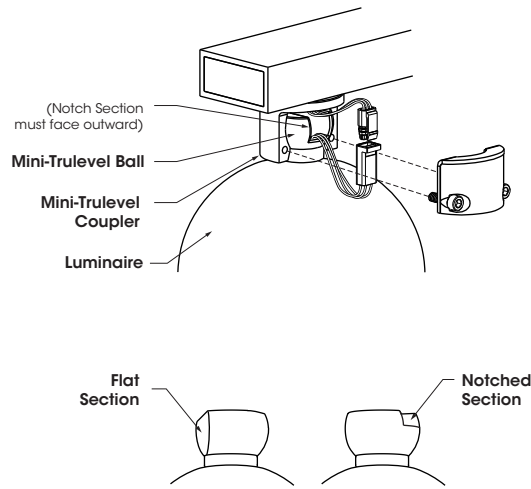

2. Place Mini-Trulevel Ball inside of Mini-Trulevel Coupler as illustrated.
 - A - Notched Section of Mini-Trulevel Ball must face outward.
 - B - Flat Section of Mini-Trulevel Ball must face inward.

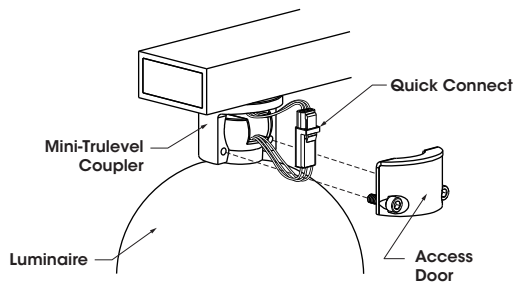

3. Connect Quick Connect components, push components inside of Mini-Trulevel Coupler cavity, replace Access Door and loosely secure, do not tighten. Fixture will suspend without Access Door during installation.

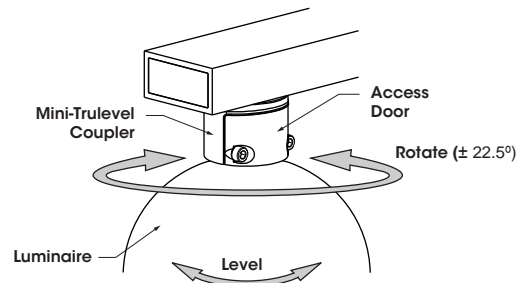

4. Rotate (left to right $\pm 22.5^\circ$) and level Luminaire to desired position. Tighten Access Door.
 - (Tighten each bolt to recommended torque: **10 ft-lb, foot-pound**)
 - Mini-Trulevel Pendant Mount is intended to allow for fixture leveling, but is not intended to be "free-swinging" upon proper installation.

LED/ELECTRICAL GUIDE

LED Count	Applied B-U-G Rating	Source	Initial Lumens - 4000K CCT	Initial Lumens - 3000K CCT	Initial Lumens - 5000K CCT	L70 greater than (HR)	Starting Temp.	System Watts	Volts	Max Input Amps
20	III B1-U0-G1 VSQ B2-U0-G0	20 PLED® Optical Module - 350mA	2023 -	1922 -	2124 -	90,000+	-40°C	22	120	.18
			2376	2258	2494				277	.08
									347	.06
20	III B1-U0-G1 VSQ B2-U0-G1	20 PLED® Optical Module - 525mA	2871 -	2728 -	3014 -	90,000+	-40°C	33	120	.28
			3373	3204	A3541				277	.12
									347	.10
20	III B1-U0-G1 VSQ B3-U0-G1	20 PLED® Optical Module - 700mA	3602 -	3422 -	3781 -	90,000+	-40°C	44	120	.37
			4231	4020	4442				277	.16
									347	.13
20	III B1-U0-G1 VSQ B3-U0-G1	20 PLED® Optical Module - 875mA	4328 -	4112 -	4544 -	90,000+	-40°C	55	120	.46
			5084	4830	5338				277	.20
									347	.16
20	III B1-U0-G2 VSQ B3-U0-G1	20 PLED® Optical Module - 1050mA	5035 -	4784 -	5286 -	90,000+	-40°C	66	120	.55
			5915	5619	6210				277	.24
									347	.19
36	III B1-U0-G1 VSQ B3-U0-G1	36 PLED® Optical Module - 350mA	3642 -	3641 -	3824 -	90,000+	-40°C	39.6	120	.33
			4278	4065	4491				277	.14
									347	.11
36	III B2-U0-G2 VSQ B3-U0-G1	36 PLED® Optical Module - 525mA	5172 -	4914 -	5430 -	90,000+	-40°C	59.4	120	.50
			6075	5772	6377				277	.21
									347	.17
36	III B2-U0-G2 VSQ B3-U0-G2	36 PLED® Optical Module - 700mA	6485 -	6161 -	6808 -	90,000+	-40°C	79.2	120	.66
			7616	7236	7995				277	.29
									347	.23
36	III B2-U0-G2 VSQ B3-U0-G2	36 PLED® Optical Module - 875mA	7794 -	7405 -	8182 -	90,000+	-40°C	99	120	.83
			9154	8697	9610				277	.36
									347	.29
36	III B2-U0-G2 VSQ B4-U0-G2	36 PLED® Optical Module - 1050mA	9069 -	8616 -	9521 -	90,000+	-40°C	118.8	120	.99
			10651	10119	11183				277	.43
									347	.34
48	III B1-U0-G1 VSQ B3-U0-G1	48 PLED® Optical Module - 350mA	4857 -	4614 -	5099 -	90,000+	-40°C	52.8	120	.44
			5704	5419	5990				277	.19
									347	.15
48	III B2-U0-G2 VSQ B3-U0-G2	48 PLED® Optical Module - 525mA	6896 -	6552 -	7239 -	90,000+	-40°C	79.2	120	.66
			8100	7696	8504				277	.29
									347	.23
48	III B2-U0-G2 VSQ B3-U0-G2	48 PLED® Optical Module - 700mA	8645 -	8214 -	9075 -	90,000+	-40°C	105.6	120	.88
			10153	9647	10660				277	.38
									347	.30
48	III B2-U0-G2 VSQ B4-U0-G2	48 PLED® Optical Module - 875mA	10393 -	9874 -	10911 -	90,000+	-40°C	132	120	1.10
			12207	11597	12816				277	.48
									347	.38

LED Count	Applied B-U-G Rating	Source	Initial Lumens - 4000K CCT	Initial Lumens - 3000K CCT	Initial Lumens - 5000K CCT	L70 greater than (HR)	Starting Temp.	System Watts	Volts	Max Input Amps
True Amber LED - 590nm										
20	III B0-U0-G0 VSQ B1-U0-G0	20 PLED® Optical Module - 350mA	606 - 712			90,000+	-40°C	17	120	.14
									277	.06
									347	.05
20	III B0-U0-G0 VSQ B1-U0-G0	20 PLED® Optical Module - 525mA	861 - 1011			90,000+	-40°C	25.4	120	.21
									277	.09
									347	.07
36	III B0-U0-G0 VSQ B1-U0-G0	36 PLED® Optical Module - 350mA	1094 - 1284			90,000+	-40°C	30.5	120	.25
									277	.11
									347	.09
36	III B1-U0-G1 VSQ B1-U0-G0	36 PLED® Optical Module - 525mA	1552 - 1823			90,000+	-40°C	45.7	120	.38
									277	.16
									347	.13
48	III B1-U0-G0 VSQ B1-U0-G0	48 PLED® Optical Module - 350mA	1457 - 1711			90,000+	-40°C	40.7	120	.34
									277	.15
									347	.12
48	III B1-U0-G1 VSQ B2-U0-G0	48 PLED® Optical Module - 525mA	2069 - 2431			90,000+	-40°C	61	120	.51
									277	.22
									347	.18

- 1) Max Input Amps is the highest of starting, operating, or open circuit currents
- 2) System Watts includes the source watts and all driver components.
- 3) Lumen values for LED Modules vary according to the distribution type
- 4) Fuse value should be sufficient to protect all wiring components. For electronic driver and LED component protection, use 20KV surge suppressors.
- 5) L70(10K) - TM-21 6x rule applied

WARNING: All fixtures must be installed in accordance with local codes or the National Electrical Code. Failure to do so may result in serious personal injury.

SOLID STATE LIGHTING

MRB-CPA WALL MOUNT-PLED

Luminaire

One piece unitized precise heavy wall cast aluminum construction comprised of low copper (A356 alloy; <0.2% Cu) aluminum. Hood is fastened to the Housing with a stainless steel hinge and secured with a tool-less stainless steel latch 180° opposite the hinge. Clear Patterned Acrylic enclosure is gasketed at the fixture Mounting Hub and crown with an extruded closed cell silicone gasket. Driver/wiring access is inside the enclosure and accesses through the top of the Mounting Hub. Hub accommodates a 2 7/8" x 3" tenon. All exposed hardware is stainless steel.

Decorative Arm

One piece unitized decorative arm assembly and Wall Mount Plate consisting of cast low copper (A356 alloy; <0.2% Cu) aluminum. Arm is welded to the Wall Mount plate and to either the LCKM13 Hood (XKM-P) or Hub (XKM-T) or both (XKM-TP). All welds are blended to create a homogeneous appearance. Wall Mount plate affixed to mounting surface covering a recessed j-box.

PLED™ Optics

Emitters (LED's) are arrayed on a metal core PCB panel with each emitter located on a copper thermal transfer pad and enclosed by an LED refractor. LED optics completely seal each individual emitter to meet an IP66 rating. In asymmetric distributions, a micro-reflector inside the refractor re-directs the house side emitter output towards the street side and functions as a house side shielding element. Refractors are injection molded H12 acrylic. Each LED refractor is sealed to the PCB over an emitter and all refractors are retained by an aluminum frame. Any one Panel, or group of Panels in a luminaire, have the same optical pattern. LED refractors produce standard site/area distributions. Panels are field replaceable and field rotatable in 90° increments and meet an IP66 rating.

LED Emitters

High output LED's are utilized with drive currents ranging from 350mA to 1050mA. 70CRI Minimum. LED's are available in standard Neutral White (4000K), or optional Cool White (5000K) or Warm White (3000K). Consult Factory for other LED options.

LED Driver

Constant current electronic with a power factor of >.90 and a minimum operating temperature of -40°F/-40°C. Driver(s) is/are UL and cUL recognized. In-line terminal blocks facilitate wiring between the driver and optical arrays. Drivers accept an input of 120-277V, 50/60Hz or 347V-480V, 50,60Hz. (0 - 10V dimmable driver is standard. Driver has a minimum of 3KV internal surge protection. Luminaire supplied with 20KV surge protector for field installation.)

Amber LED's

TRA (True Amber) LED's utilize material that emits light in the amber spectral bandwidth only without the use of phosphors.

Finish

Polyester powder coat incorporates four step iron phosphate process to pretreat metal surface for maximum adhesion. Top coat is baked at 400°F for maximum hardness and exterior durability.

PROJECT NAME: _____

FIXTURE TYPE: _____



MRBT-WM (Tenon Mount)

(MRB18 shown on WM-XMB1-UT arm)

Fixture	A	B	C	D	E	F
MRB21T-WM-WA	53" (1346mm)	21" (533mm)	28" (711mm)	17.75" (451mm)	64" (1626mm)	51.25" (1302mm)
MRB18T-WM-WA	47.25" (1200mm)	18" (457mm)	27" (686mm)	17.75" (451mm)	58" (1473mm)	47" (1194mm)

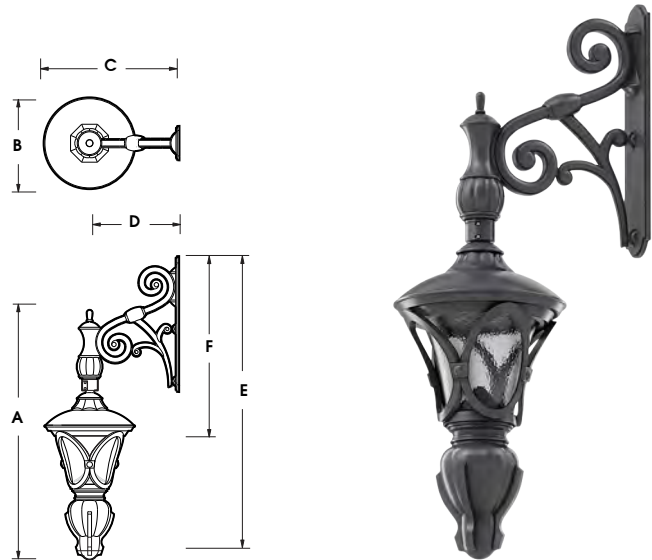

MRBP-WM (Pendant Mount)

(MRB18 shown on WM-XMB1-DP arm)

Fixture	A	B	C	D	E	F
MRB21P-WM-WA	54.5" (1384mm)	21" (533mm)	28" (711mm)	17.75" (451mm)	65" (1651mm)	37" (940mm)
MRB18P-WM-WA	49.5" (1257mm)	18" (457mm)	26.75" (679mm)	17.75" (451mm)	60.5" (1537mm)	36" (914mm)

SPECIFICATIONS

PLED™ Modules

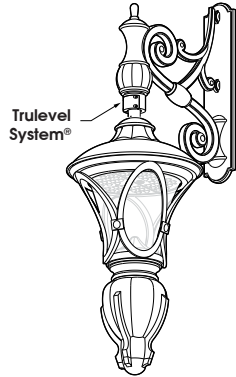
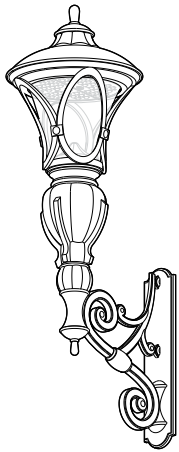

MRB21T-WM-CPA E.P.A.= 2.96
Available in:
48 LED Module Max

MRB21P-WM-CPA E.P.A.= 2.98
Available in:
48 LED Module Max

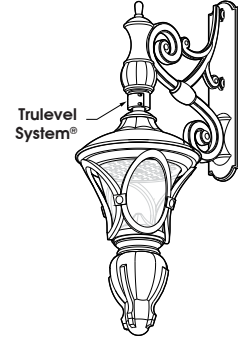

MRB18T-WM-CPA E.P.A.= 2.54
Available in:
36 LED Module Max

MRB18P-WM-CPA E.P.A.= 2.56
Available in:
36 LED Module Max

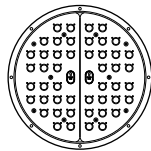

48 LED Module

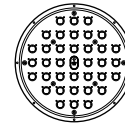

36 LED Module

MRB21T-WM-CPA E.P.A.= 2.96
Available in:
48 LED Module Max

MRB21P-WM-CPA E.P.A.= 2.98
Available in:
48 LED Module Max

MRB18T-WM-CPA E.P.A.= 2.54
Available in:
36 LED Module Max

MRB18P-WM-CPA E.P.A.= 2.56
Available in:
36 LED Module Max

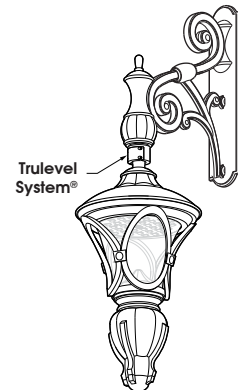
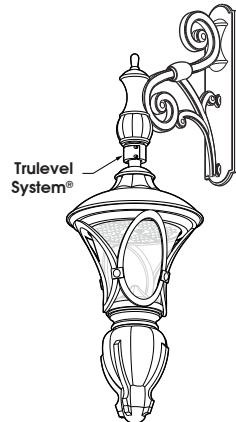

SPECIFICATIONS
Wall Mount

WM-XMB1-UT

WM-XMB1-UP



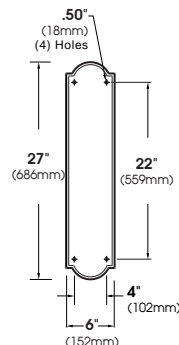



WM-XMB1-DT

WM-XMB1-DP
Wall Plate

Extruded aluminum arm and cast aluminum wall bracket assembly provided with built in gasketed wire access for fixture/supply wire connection.

SPEC/ORDERING INFORMATION

Spec/Order Example: MRB18-CPA/XMB1-DP/PLED-II/36LED-700mA/NW/277/RAL-9003-T

Luminaire	Optics	LED Mode			Voltage	Finish	Options
Luminaire	Optics	LED			Voltage	Finish	Options
<input type="checkbox"/> WM/MRB21-CPA/XMB1-UT <input type="checkbox"/> WM/MRB21-CPA/XMB1-UP <input type="checkbox"/> WM/MRB21-CPA/XMB1-DT <input type="checkbox"/> WM/MRB21-CPA/XMB1-DP <input type="checkbox"/> WM/MRB18-CPA/XMB1-UT <input type="checkbox"/> WM/MRB18-CPA/XMB1-UP <input type="checkbox"/> WM/MRB18-CPA/XMB1-DT <input type="checkbox"/> WM/MRB18-CPA/XMB1-DP	PLED[®] Distribution Type <input type="checkbox"/> Type II PLED-II  <input type="checkbox"/> Type II Front Row PLED-II-FR  <input type="checkbox"/> Type III Med. PLED-III-M  <input type="checkbox"/> Type III Wide PLED-III-W  <input type="checkbox"/> Type IV PLED-IV  <input type="checkbox"/> Type IV PLED-IV-FIT 	# of LEDs MRB21-CPA <input type="checkbox"/> 48LED ¹ <input type="checkbox"/> 36LED <input type="checkbox"/> 20LED MRB18-CPA <input type="checkbox"/> 36LED ¹ <input type="checkbox"/> 20LED	Drive Current <input type="checkbox"/> 1050mA ² <input type="checkbox"/> 875mA ² <input type="checkbox"/> 700mA ² <input type="checkbox"/> 525mA <input type="checkbox"/> 350mA	Color Temp - CCT <input type="checkbox"/> NW (4000K)* <small>*Standard</small> <input type="checkbox"/> CW (5000K) <input type="checkbox"/> WW (3000K) <small>Other LED Colors Available Consult Factory</small> <input type="checkbox"/> Amber ³ <input type="checkbox"/> True Amber ⁴ TRA	<input type="checkbox"/> 120 <input type="checkbox"/> 208 <input type="checkbox"/> 240 <input type="checkbox"/> 277 <input type="checkbox"/> 347 <input type="checkbox"/> 480	Standard Textured Finish <input type="checkbox"/> Black RAL-9005-T <input type="checkbox"/> White RAL-9003-T <input type="checkbox"/> Grey RAL-7004-T <input type="checkbox"/> Dark Bronze RAL-8019-T <input type="checkbox"/> Green RAL-6005-T <small>For smooth finish replace suffix "T" with suffix "S" (Example: RAL-9500-S)</small> <small>Consult factor for custom colors</small>	<input type="checkbox"/> Internal House Side Shield inc. LED Count (Example: HS-PLED/48) HS-PLED <input type="checkbox"/> Twist Lock Receptable Only TPR <input type="checkbox"/> 7-Pin Twist Lock Receptable Only TPR7 <input type="checkbox"/> High-Low Dimming for Switch by Others/Select Levels 50/100 or 25/100 (Example: HLSW/25) HLSW <input type="checkbox"/> Photo Cell + Voltage (Example: PC120V) PC+V <input type="checkbox"/> Single Fuse (120V, 277V) SF <input type="checkbox"/> Double Fuse (208V, 240V) DF <input type="checkbox"/> Blue-Tooth Programmable Photo/Motion Sensor (Factory - Motion 50/100; Photo 75c) MS-F311
NOTES: 1 - 875mA maximum 2 - 700mA, 875mA and 1050mA not for use with TRA LED's 3 - Narrow band Ambers have no Definable CCT equivalent 4 - Available in 350mA & 525mA drive currents only							

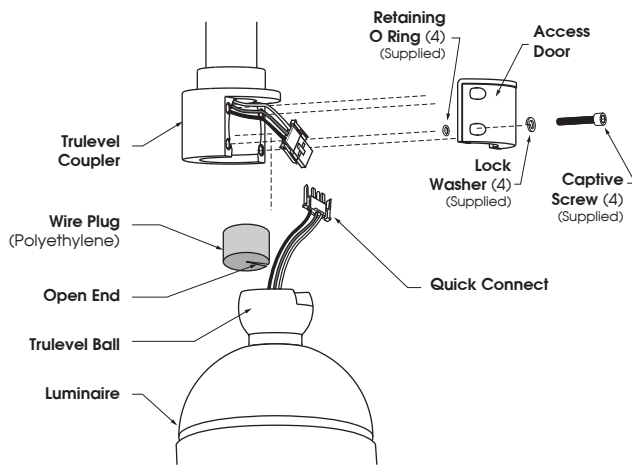
INSTALLATION DETAIL
Trulevel System® Assembly for Installation of Pendant Mount Luminaires

1. Loosen (4) Captive Screws and remove Access Door from Trulevel Coupler, pull out Quick Connect from Trulevel Coupler and Trulevel Ball.

Press open end of Wire Plug around Quick Connect wires.

Slide Wire Plug down the wires and into Trulevel Ball opening, press Neoprene firmly into opening to prevent moisture and other contaminants from entering Luminaire Assembly.

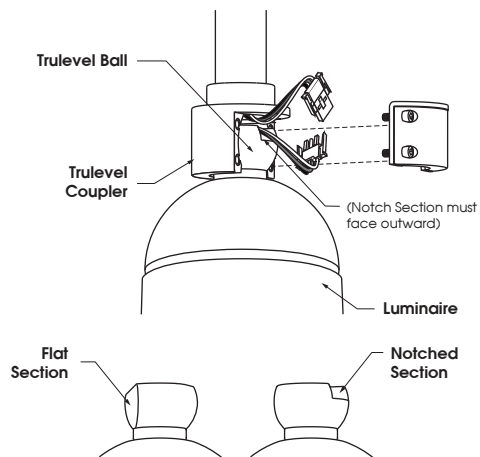

2. Place Trulevel Ball inside of Trulevel Coupler as illustrated.

A - Notched Section of Trulevel Ball must face outward as illustrated.

B - Flat Section of Trulevel Ball must face inward.

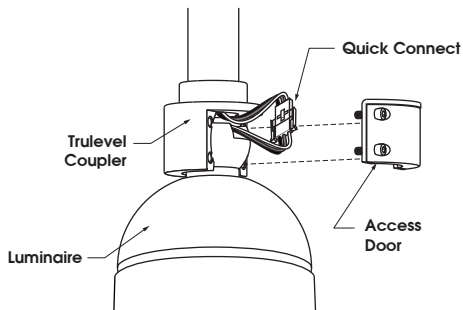

3. Connect Quick Connect components, push components inside of Trulevel Coupler cavity, replace Access Door and loosely secure, do not tighten.

Fixture will suspend without Access Door during installation.

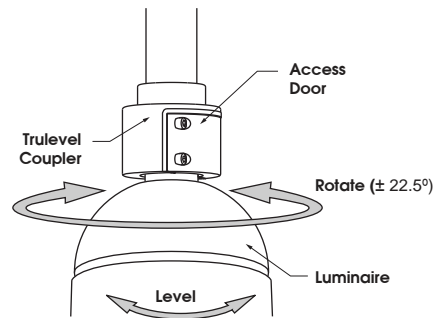

4. Rotate (left to right $\pm 22.5^\circ$) and level Luminaire to desired position. Tighten Access Door.

(Tighten each bolt to recommended torque: **10 ft-lb, foot-pound**)

Trulevel Pendant Mount is intended to allow for fixture leveling, but is not intended to be "free-swinging" upon proper installation.

LED/ELECTRICAL GUIDE

LED Count	Applied B-U-G Rating	Source	Initial Lumens - 4000K CCT	Initial Lumens - 3000K CCT	Initial Lumens - 5000K CCT	L70 greater than (HR)	Starting Temp.	System Watts	Volts	Max Input Amps
20	III B1-U1-G1 VSQ B2-U1-G0	20 PLED® Optical Module - 350mA	1909 -	1813 -	2004 -	90,000+	-40°C	22	120	0.18
			2256	2143	2368				277	0.08
									347	0.06
20	III B1-U1-G1 VSQ B2-U1-G1	20 PLED® Optical Module - 525mA	2710 -	2574 -	2846 -	90,000+	-40°C	33	120	0.28
			3203	3043	3363				277	0.12
									347	0.10
20	III B1-U1-G1 VSQ B3-U1-G1	20 PLED® Optical Module - 700mA	3398 -	3228 -	3567 -	90,000+	-40°C	44	120	0.37
			4015	3814	4216				277	0.16
									347	0.13
20	III B1-U1-G1 VSQ B3-U1-G1	20 PLED® Optical Module - 875mA	4085 -	3881 -	4289 -	90,000+	-40°C	55	120	0.46
			4827	4586	5068				277	0.20
									347	0.16
20	III B1-U2-G2 VSQ B3-U1-G1	20 PLED® Optical Module - 1050mA	4752 -	4514 -	4989 -	90,000+	-40°C	66	120	0.55
			5617	5336	5897				277	0.24
									347	0.19
36	III B1-U3-G1 VSQ B2-U3-G1	36 PLED® Optical Module - 350mA	3436 -	3264 -	3607 -	90,000+	-40°C	39.6	120	0.33
			4061	3857	4263				277	0.14
									347	0.11
36	III B1-U3-G2 VSQ B3-U3-G1	36 PLED® Optical Module - 525mA	4879 -	4634 -	5122 -	90,000+	-40°C	59.4	120	0.50
			5766	5478	6054				277	0.21
									347	0.17
36	III B2-U3-G2 VSQ B3-U3-G2	36 PLED® Optical Module - 700mA	6116 -	5810 -	6421 -	90,000+	-40°C	79.2	120	0.66
			7228	6866	7591				277	0.29
									347	0.23
36	III B2-U3-G2 VSQ B3-U3-G2	36 PLED® Optical Module - 875mA	7353 -	6985 -	7721 -	90,000+	-40°C	99	120	0.83
			8690	8256	9124				277	0.36
									347	0.29
36	III B2-U3-G2 VSQ B3-U3-G2	36 PLED® Optical Module - 1050mA	8555 -	8127 -	8983 -	90,000+	-40°C	118.8	120	0.99
			10110	9604	10616				277	0.43
									347	0.34
48	III B1-U3-G2 VSQ B2-U3-G2	48 PLED® Optical Module - 350mA	4581 -	4352 -	4810 -	90,000+	-40°C	52.8	120	0.44
			5414	5144	5685				277	0.19
									347	0.15
48	III B2-U3-G2 VSQ B2-U4-G3	48 PLED® Optical Module - 525mA	6505 -	6180 -	6830 -	90,000+	-40°C	79.2	120	0.66
			7688	7303	8073				277	0.29
									347	0.23
48	III B2-U3-G2 VSQ B3-U4-G3	48 PLED® Optical Module - 700mA	8155 -	7747 -	8562 -	90,000+	-40°C	105.6	120	0.88
			9638	9156	10118				277	0.38
									347	0.30
48	III B2-U3-G3 VSQ B3-U4-G3	48 PLED® Optical Module - 875mA	9804 -	9313 -	10294 -	90,000+	-40°C	132	120	
			11586	11007	12166				277	
									347	

LED Count	Applied B-U-G Rating	Source	Initial Lumens - 4000K CCT	Initial Lumens - 3000K CCT	Initial Lumens - 5000K CCT	L70 greater than (HR)	Starting Temp.	System Watts	Volts	Max Input Amps
True Amber LED - 590nm										
20	III B0-U2-G1 VSQ B1-U2-G1	20 PLED® Optical Module - 350mA	573 -			90,000+	-40°C	17	120	0.14
			677						277	0.06
									347	0.05
20	III B0-U2-G1 VSQ B1-U2-G1	20 PLED® Optical Module - 525mA	813 -			90,000+	-40°C	25.4	120	0.21
			961						277	0.09
									347	0.07
36	III B0-U2-G1 VSQ B1-U2-G1	36 PLED® Optical Module - 350mA	1032 -			90,000+	-40°C	30.5	120	0.25
			1219						277	0.11
									347	0.09
36	III B1-U2-G1 VSQ B1-U2-G1	36 PLED® Optical Module - 525mA	1464 -			90,000+	-40°C	45.7	120	0.38
			1730						277	0.16
									347	0.13
48	III B1-U2-G1 VSQ B1-U2-G1	48 PLED® Optical Module - 350mA	1375 -			90,000+	-40°C	40.7	120	0.34
			1625						277	0.15
									347	0.12
48	III B1-U2-G1 VSQ B2-U2-G1	48 PLED® Optical Module - 525mA	1952 -			90,000+	-40°C	61	120	0.51
			2307						277	0.22
									347	0.18

1) Max Input Amps is the highest of starting, operating, or open circuit currents

2) System Watts includes the source watts and all driver components.

3) Lumen values for LED Modules vary according to the distribution type

4) Fuse value should be sufficient to protect all wiring components. For electronic driver and LED component protection, use 20KV surge suppressors.

5) L70(10K) - TM-21 6x rule applied

WARNING: All fixtures must be installed in accordance with local codes or the National Electrical Code. Failure to do so may result in serious personal injury.

SOLID STATE LIGHTING

MRB-WA WALL MOUNT-PLED

Luminaire and Enclosure

One piece unitized precise heavy wall cast aluminum construction comprised of low copper (A356 alloy; <0.2% Cu) aluminum. Hood is fastened to the Housing with a stainless steel hinge and secured with a tool-less stainless steel latch 180° opposite the hinge. White Acrylic enclosure is gasketed at the fixture Mounting Hub and crown with an extruded closed cell silicone gasket. Driver/wiring access is inside the enclosure and accesses through the top of the Mounting Hub. Hub accommodates a 2 $\frac{7}{8}$ " x 3" tenon. All exposed hardware is stainless steel.

Decorative Arm

One piece unitized decorative arm assembly and Wall Mount Plate consisting of cast low copper (A356 alloy; <0.2% Cu) aluminum. Arm is welded to the Wall Mount plate and to either the LCKM13 Hood (XKM-P) or Hub (XKM-T) or both (XKM-TP). All welds are blended to create a homogeneous appearance. Wall Mount plate affixed to mounting surface covering a recessed j-box.

PLED™ Optics

Emitters (LED's) are arrayed on a metal core PCB panel with each emitter located on a copper thermal transfer pad and enclosed by an LED refractor. LED optics completely seal each individual emitter to meet an IP66 rating. In asymmetric distributions, a micro-reflector inside the refractor re-directs the house side emitter output towards the street side and functions as a house side shielding element. Refractors are injection molded H12 acrylic. Each LED refractor is sealed to the PCB over an emitter and all refractors are retained by an aluminum frame. Any one Panel, or group of Panels in a luminaire, have the same optical pattern. Panels are field replaceable and meet an IP66 rating.

PLED Optics w/ -WA Enclosure

ASY-W1 distribution uses PLED-II Optic with -WA
 ASY-W2 distribution uses PLED-II/HSS Optic with -WA
 ASY-N1 distribution uses PLED-IV-FT Optic with -WA
 ASY-N2 distribution uses PLED-IV-FT/HSS Optic with -WA
 SYM distribution uses PLED-VSQ-M Optic with -WA

LED Emitters

High output LED's are utilized with drive currents ranging from 350mA to 1050mA. 70CRI Minimum. LED's are available in standard Neutral White (4000K), or optional Cool White (5000K) or Warm White (3000K). Consult Factory for other LED options.

LED Driver

Constant current electronic with a power factor of >.90 and a minimum operating temperature of -40°F/-40°C. Driver(s) is/are UL and cUL recognized. In-line terminal blocks facilitate wiring between the driver and optical arrays. Drivers accept an input of 120-277V, 50/60Hz or 347V-480V, 50,60Hz. (0 - 10V dimmable driver is standard. Driver has a minimum of 3KV internal surge protection. Luminaire supplied with 20KV surge protector for field installation.)

Amber LED's

TRA (True Amber) LED's utilize material that emits light in the amber spectral bandwidth only without the use of phosphors.

Finish

Polyester powder coat incorporates four step iron phosphate process to pretreat metal surface for maximum adhesion. Top coat is baked at 400°F for maximum hardness and exterior durability.

PROJECT NAME: _____

FIXTURE TYPE: _____



MRBT-WM (Tenon Mount)

(MRB18 shown on WM-XMB1-UT arm)

Fixture	A	B	C	D	E	F
MRB21T-WM-WA	5" (1346mm)	21" (533mm)	28" (711mm)	17.75" (451mm)	64" (1626mm)	51.25" (1302mm)
MRB18T-WM-WA	47.255" (1200mm)	18" (457mm)	27" (686mm)	17.75" (451mm)	58" (1473mm)	47" (1194mm)



MRBP-WM (Pendant Mount)

(MRB18 shown on WM-XMB1-DP arm)

Fixture	A	B	C	D	E	F
MRB21P-WM-WA	54.5" (1384mm)	21" (533mm)	28" (711mm)	17.75" (451mm)	65" (1651mm)	37" (921mm)
MRB18P-WM-WA	49" (1245mm)	18" (457mm)	27" (686mm)	17.75" (451mm)	60" (1524mm)	36" (914mm)

SPECIFICATIONS

PLED™ Modules

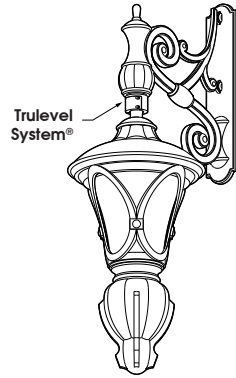
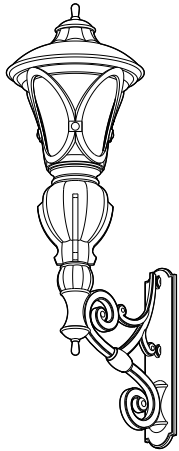

MRB21T-WM-WA E.P.A.= 2.96
Available in:
48 LED Module Max

MRB21P-WM-WA E.P.A.= 2.98
Available in:
48 LED Module Max

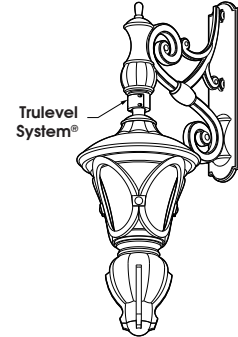

MRB18T-WM-WA E.P.A.= 2.54
Available in:
36 LED Module Max

MRB18P-WM-WA E.P.A.= 2.56
Available in:
36 LED Module Max

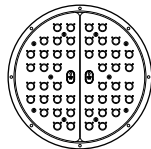

48 LED Module

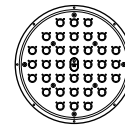

36 LED Module

MRB21T-WM-WA E.P.A.= 2.96
Available in:
48 LED Module Max

MRB21P-WM-WA E.P.A.= 2.98
Available in:
48 LED Module Max

MRB18T-WM-WA E.P.A.= 2.54
Available in:
36 LED Module Max

MRB18P-WM-WA E.P.A.= 2.56
Available in:
36 LED Module Max

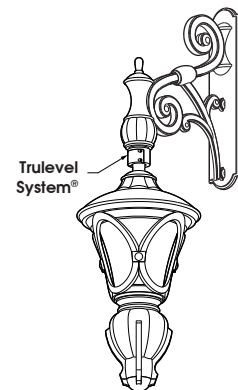
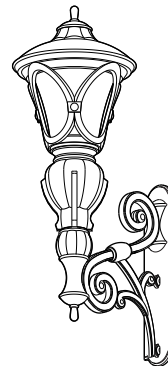
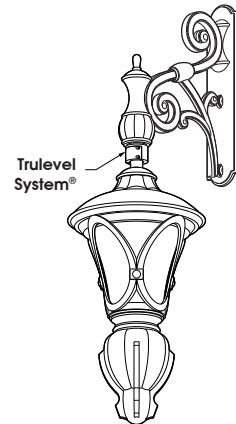
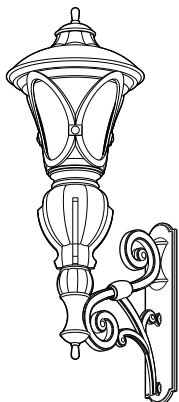

SPECIFICATIONS
Wall Mount

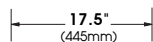

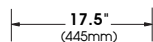
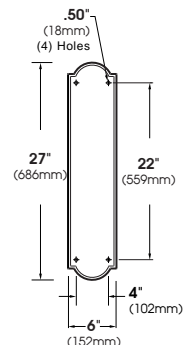

WM-XMB1-UT

WM-XMB1-DT

WM-XMB1-UP

WM-XMB1-DP
Wall Plate

Extruded aluminum arm and cast aluminum wall bracket assembly provided with built in gasketed wire access for fixture/supply wire connection.

SPEC/ORDERING INFORMATION

Spec/Order Example: MRB21-WA/XMB1-UT/PLED-SYM/48LED-875mA/WW/277/RAL-9005T

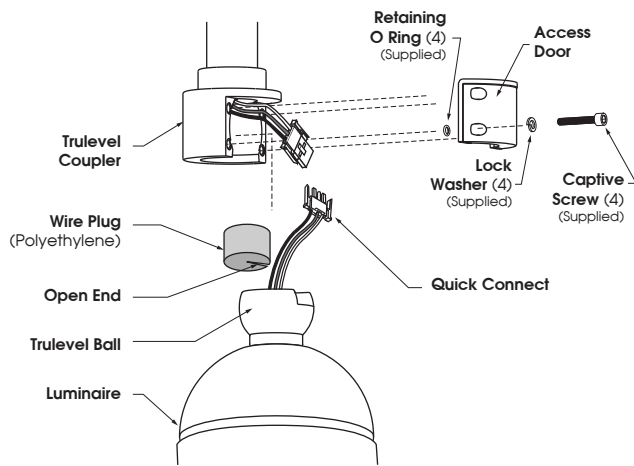
Luminaire	Optics	LED Mode			Voltage	Finish	Options
Luminaire	Optics	LED			Voltage	Finish	Options
<input type="checkbox"/> WM/MRB21-WA/XMB1-UT <input type="checkbox"/> WM/MRB21-WA/XMB1-UP <input type="checkbox"/> WM/MRB21-WA/XMB1-DT <input type="checkbox"/> WM/MRB21-WA/XMB1-DP <input type="checkbox"/> WM/MRB18-WA/XMB1-UT <input type="checkbox"/> WM/MRB18-WA/XMB1-UP <input type="checkbox"/> WM/MRB18-WA/XMB1-DT <input type="checkbox"/> WM/MRB18-WA/XMB1-DP	PLED™ Distribution Type <input type="checkbox"/> Type Asymmetric PLED-ASY-W1  <input type="checkbox"/> Type Asymmetric PLED-ASY-W2  w/HouseSide Shield <input type="checkbox"/> Type Asymmetric PLED-ASY-N1  <input type="checkbox"/> Type Asymmetric PLED-ASY-N2  w/HouseSide Shield <input type="checkbox"/> Type Symmetric PLED-SYM 	# of LEDs MRB21-WA <input type="checkbox"/> 48LED ¹ <input type="checkbox"/> 36LED <input type="checkbox"/> 20LED MRB18-WA <input type="checkbox"/> 36LED ¹ <input type="checkbox"/> 20LED	Drive Current <input type="checkbox"/> 1050mA ² <input type="checkbox"/> 875mA ² <input type="checkbox"/> 700mA ² <input type="checkbox"/> 525mA <input type="checkbox"/> 350mA	Color Temp - CCT <input type="checkbox"/> NW (4000K)* *Standard <input type="checkbox"/> CW (5000K) <input type="checkbox"/> WW (3000K) Other LED Colors Available Consult Factory Amber ³ <input type="checkbox"/> True Amber ⁴ TRA	<input type="checkbox"/> 120 <input type="checkbox"/> 208 <input type="checkbox"/> 240 <input type="checkbox"/> 277 <input type="checkbox"/> 347 <input type="checkbox"/> 480	Standard Textured Finish <input type="checkbox"/> Black RAL-9005-T <input type="checkbox"/> White RAL-9003-T <input type="checkbox"/> Grey RAL-7004-T <input type="checkbox"/> Dark Bronze RAL-8019-T <input type="checkbox"/> Green RAL-6005-T For smooth finish replace suffix "T" with suffix "S" (Example: RAL-9500-S) Consult factor for custom colors	<input type="checkbox"/> Internal House Side Shield inc. LED Count (Example: HS-PLED/48) HS-PLED <input type="checkbox"/> Twist Lock Receptable Only TPR <input type="checkbox"/> 7-Pin Twist Lock Receptable Only TPR7 <input type="checkbox"/> High-Low Dimming for Switch by Others/Select Levels 50/100 or 25/100 (Example: HLSW/25) HLSW <input type="checkbox"/> Photo Cell + Voltage (Example: PC120V) PC+V <input type="checkbox"/> Single Fuse (120V, 277V) SF <input type="checkbox"/> Double Fuse (208V, 240V) DF <input type="checkbox"/> Blue-Tooth Programmable Photo/Motion Sensor (Factory - Motion 50/100; Photo 75c) MS-F311
NOTES: 1 - 875mA maximum 2 - 700mA, 875mA and 1050mA not for use with TRA LED's 3 - Narrow band Ambers have no Definable CCT equivalent 4 - Available in 350mA & 525mA drive currents only							

INSTALLATION DETAIL
Trulevel System® Assembly for Installation of Pendant Mount Luminaires

1. Loosen (4) Captive Screws and remove Access Door from Trulevel Coupler, pull out Quick Connect from Trulevel Coupler and Trulevel Ball.

Press open end of Wire Plug around Quick Connect wires.

Slide Wire Plug down the wires and into Trulevel Ball opening, press Neoprene firmly into opening to prevent moisture and other contaminants from entering Luminaire Assembly.

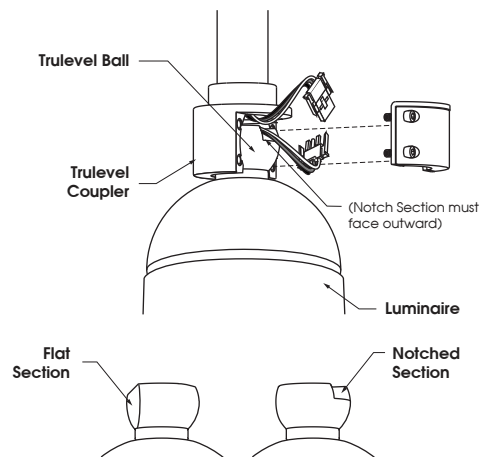

2. Place Trulevel Ball inside of Trulevel Coupler as illustrated.
 A - Notched Section of Trulevel Ball must face outward as illustrated.
 B - Flat Section of Trulevel Ball must face inward.

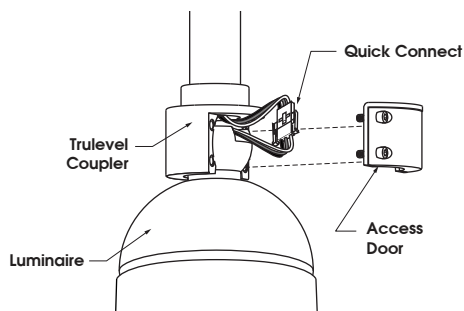

3. Connect Quick Connect components, push components inside of Trulevel Coupler cavity, replace Access Door and loosely secure, do not tighten.

Fixture will suspend without Access Door during installation.

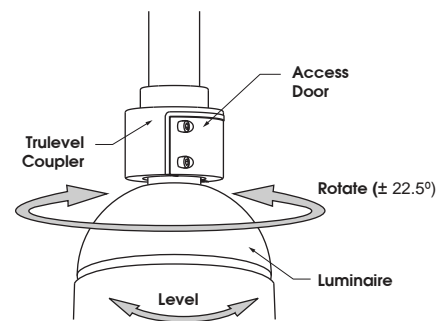

4. Rotate (left to right $\pm 22.5^\circ$) and level Luminaire to desired position. Tighten Access Door.

(Tighten each bolt to recommended torque: **10 ft-lb, foot-pound**)

Trulevel Pendant Mount is intended to allow for fixture leveling, but is not intended to be "free-swinging" upon proper installation.

LED/ELECTRICAL GUIDE

LED Count	Applied B-U-G Rating	Source	Initial Lumens - 4000K CCT	Initial Lumens - 3000K CCT	Initial Lumens - 5000K CCT	L70 greater than (HR)	Starting Temp.	System Waits	Volts	Max Input Amps
20	III B1-U3-G1 VSQ B1-U3-G1	20 PLED® Optical Module - 350mA	1139 -	1082 -	1195 -	90,000+	-40°C	22	120	0.18
			1653	1569	1735				277	0.08
									347	0.06
20	III B1-U3-G2 VSQ B1-U3-G2	20 PLED® Optical Module - 525mA	1617 -	1536 -	1698 -	90,000+	-40°C	33	120	0.28
			2347	2229	2464				277	0.12
									347	0.10
20	III B1-U3-G2 VSQ B1-U3-G2	20 PLED® Optical Module - 700mA	2027 -	1926 -	2129 -	90,000+	-40°C	44	120	0.37
			2942	2794	3089				277	0.16
									347	0.13
20	III B1-U3-G2 VSQ B2-U3-G2	20 PLED® Optical Module - 875mA	2437 -	2315 -	2559 -	90,000+	-40°C	55	120	0.46
			3537	3360	3713				277	0.20
									347	0.16
20	III B1-U3-G3 VSQ B2-U3-G2	20 PLED® Optical Module - 1050mA	2836 -	2694 -	2977 -	90,000+	-40°C	66	120	0.55
			4115	3909	4320				277	0.24
									347	0.19
36	III B1-U3-G2 VSQ B1-U3-G2	36 PLED® Optical Module - 350mA	2050 -	1948 -	2153 -	90,000+	-40°C	39.6	120	0.33
			2974	2825	3123				277	0.14
									347	0.11
36	III B1-U3-G3 VSQ B2-U3-G3	36 PLED® Optical Module - 525mA	2911 -	2766 -	3056 -	90,000+	-40°C	59.4	120	0.50
			4223	4011	4434				277	0.21
									347	0.17
36	III B2-U4-G3 VSQ B2-U4-G3	36 PLED® Optical Module - 700mA	3949 -	3467 -	3832 -	90,000+	-40°C	79.2	120	0.66
			5293	5028	5558				277	0.29
									347	0.23
36	III B2-U4-G3 VSQ B2-U4-G3	36 PLED® Optical Module - 875mA	4388 -	4168 -	4607 -	90,000+	-40°C	99	120	0.83
			6364	6046	6682				277	0.36
									347	0.29
36	III B2-U4-G3 VSQ B2-U4-G3	36 PLED® Optical Module - 1050mA	5105 -	4850 -	8983 -	90,000+	-40°C	118.8	120	0.99
			7405	7034	10616				277	0.43
									347	0.34
48	III B1-U3-G3 VSQ B2-U3-G2	48 PLED® Optical Module - 350mA	2734 -	2597 -	2870 -	90,000+	-40°C	52.8	120	0.44
			3965	3767	4163				277	0.19
									347	0.15
48	III B2-U4-G3 VSQ B2-U4-G3	48 PLED® Optical Module - 525mA	3882 -	3687 -	4075 -	90,000+	-40°C	79.2	120	0.66
			5631	5349	5912				277	0.29
									347	0.23
48	III B2-U4-G3 VSQ B3-U4-G3	48 PLED® Optical Module - 700mA	4866 -	4623 -	5109 -	90,000+	-40°C	105.6	120	0.88
			7058	6705	7411				277	0.38
									347	0.30
48	III B2-U4-G3 VSQ B3-U4-G3	48 PLED® Optical Module - 875mA	5850 -	5557 -	6142 -	90,000+	-40°C	132	120	1.10
			8485	8060	8909				277	0.48
									347	0.38

LED Count	Applied B-U-G Rating	Source	Initial Lumens - 4000K CCT	Initial Lumens - 3000K CCT	Initial Lumens - 5000K CCT	L70 greater than (HR)	Starting Temp.	System Watts	Volts	Max Input Amps
True Amber LED - 590nm										
20	III B0-U3-G1 V5Q B0-U3-G1	20 PLED® Optical Module - 350mA				90,000+	-40°C	17	120	
									277	
									347	
20	III B0-U3-G1 V5Q B1-U3-G1	20 PLED® Optical Module - 525mA				90,000+	-40°C	25.4	120	
									277	
									347	
36	III B0-U3-G1 V5Q B1-U3-G1	36 PLED® Optical Module - 350mA				90,000+	-40°C	30.5	120	
									277	
									347	
36	III B1-U3-G1 V5Q B1-U3-G1	36 PLED® Optical Module - 525mA				90,000+	-40°C	45.7	120	
									277	
									347	
48	III B1-U3-G1 V5Q B1-U3-G1	48 PLED® Optical Module - 350mA				90,000+	-40°C	40.7	120	
									277	
									347	
48	III B1-U3-G1 V5Q B1-U3-G1	48 PLED® Optical Module - 525mA				90,000+	-40°C	61	120	
									277	
									347	

- 1) Max Input Amps is the highest of starting, operating, or open circuit currents
- 2) System Watts includes the source watts and all driver components.
- 3) Lumen values for LED Modules vary according to the distribution type
- 4) Fuse value should be sufficient to protect all wiring components. For electronic driver and LED component protection, use 20KV surge suppressors.
- 5) L70(10K) – TM-21 6x rule applied

WARNING: All fixtures must be installed in accordance with local codes or the National Electrical Code. Failure to do so may result in serious personal injury.